

# BOX NEWELS

**All Stile & Rail Newels** - Will have solid 1-3/8" stile, 3/4" Rails and 3/4" Raised or Flat panels.

**Flat and Raised Panel Newels** - Available with Roman Ogee, Panel Cap, Flat and Raise Panels.

**Chamfered Newels** - Hollow Newels are Spline Jointed, Solid Newels are Laminated.

**Plant-on Newels** - All Plant on Newels will use HM503 Molding.

**Rosettes** - Sold separately and unattached.

**Hollow Posts** - With no detail will have Lock Mitered Corners.

## NEWEL TYPE

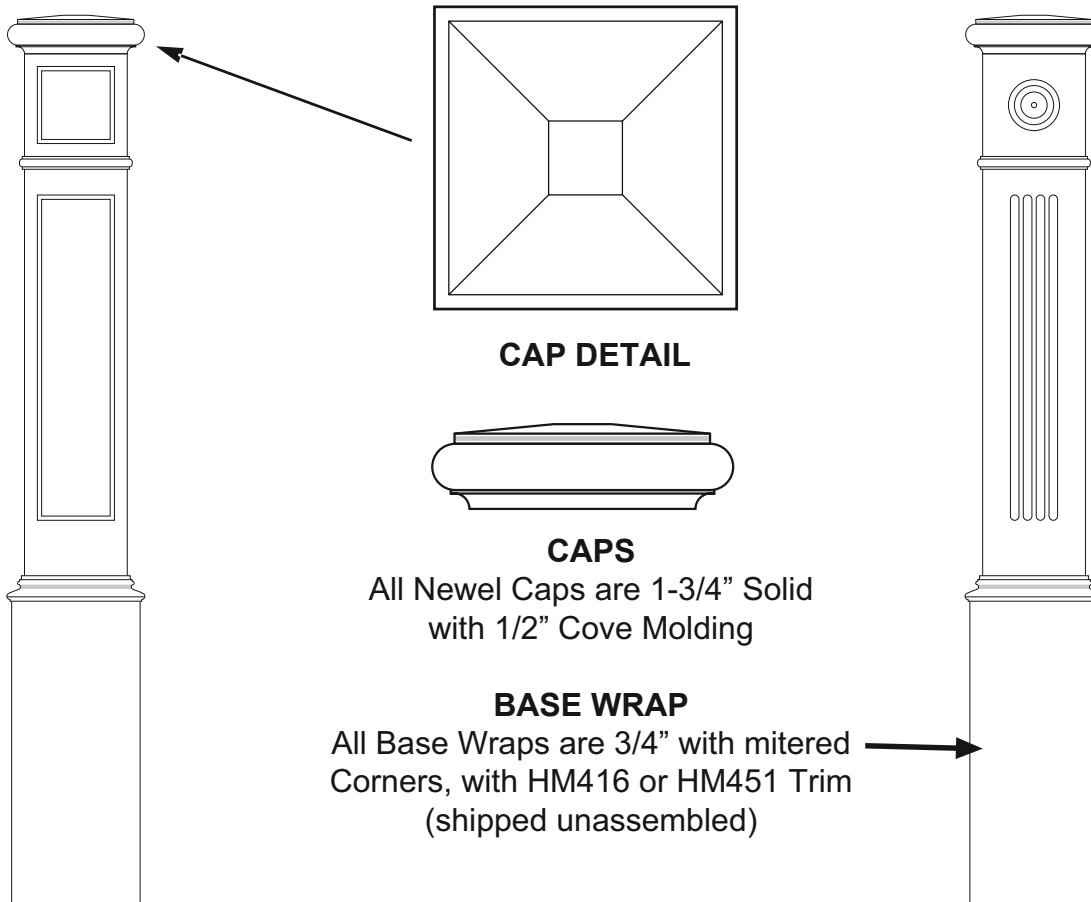
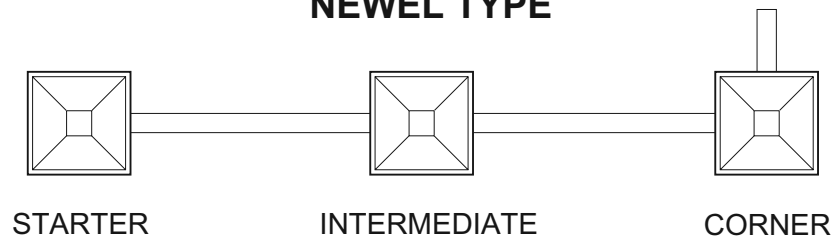

# BOX NEWEL GUIDE

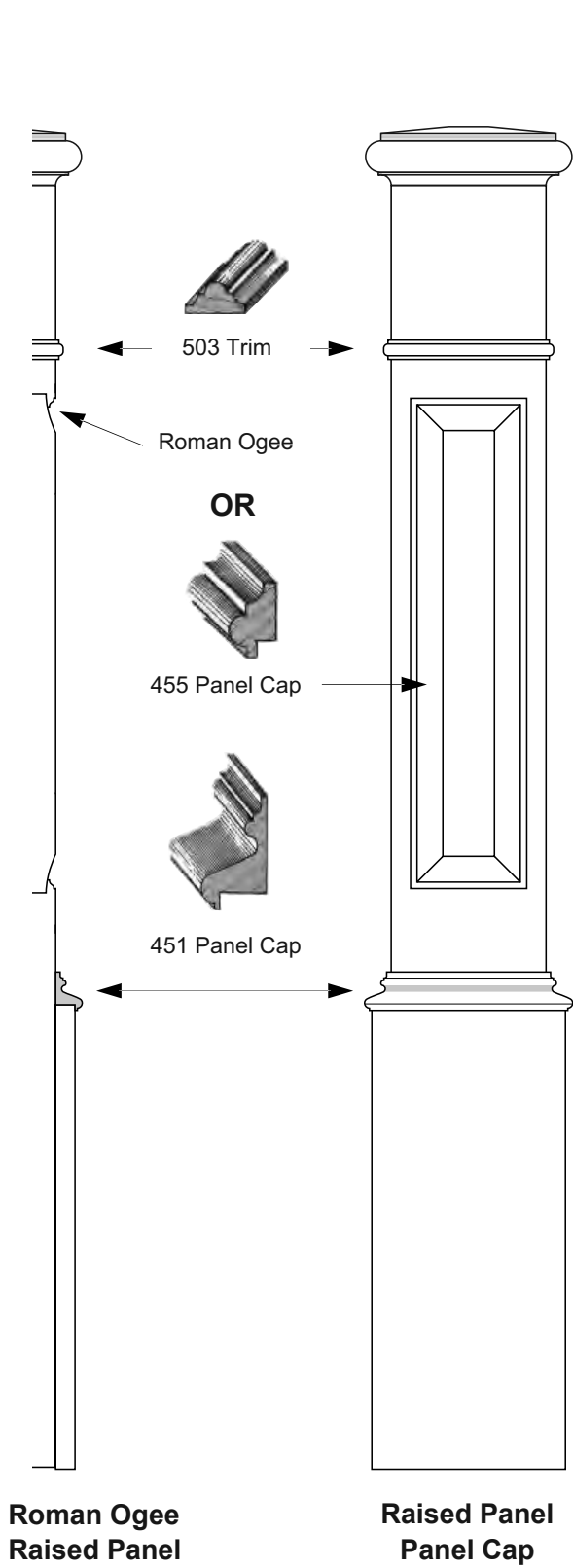

Unattached Base Wrap and Trim Available  
Drawing not to Scale

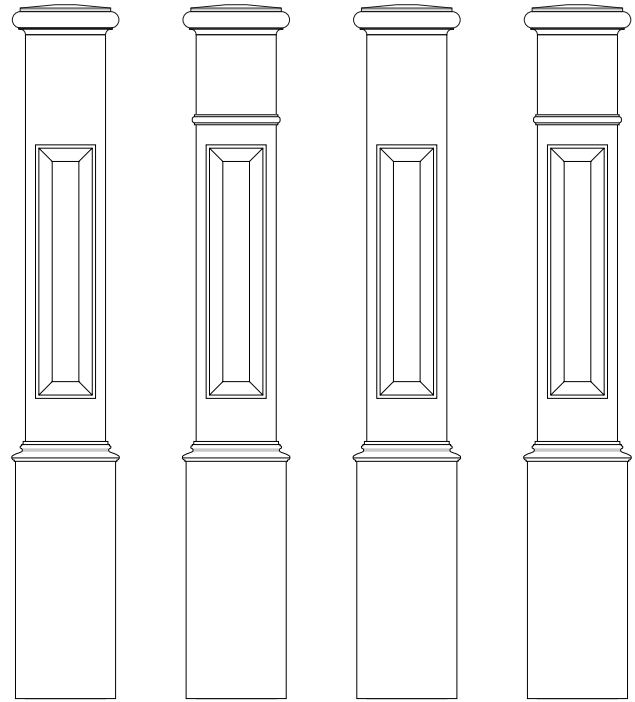

**#1**  
Raised Panel  
Roman Ogee

**#2**  
Raised Panel  
Roman Ogee  
w/503 Trim  
Band

**#3**  
Raised Panel  
w/455

**#4**  
Raised Panel  
w/455 & 503  
Trim Band

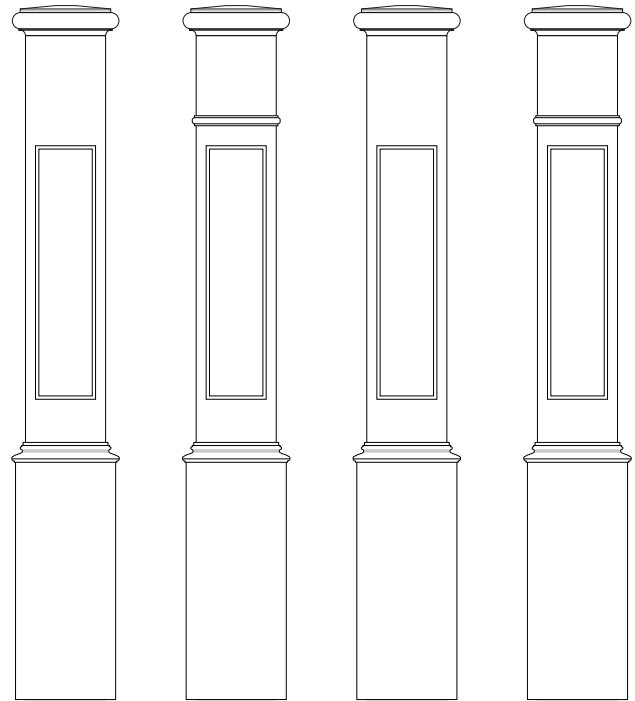

**#5**  
Flat Panel  
Roman Ogee

**#6**  
Flat Panel  
Roman Ogee  
w/503 Trim  
Band

**#7**  
Flat Panel  
w/455

**#8**  
Flat Panel  
w/455 & 503  
Trim Band

# BOX NEWELS

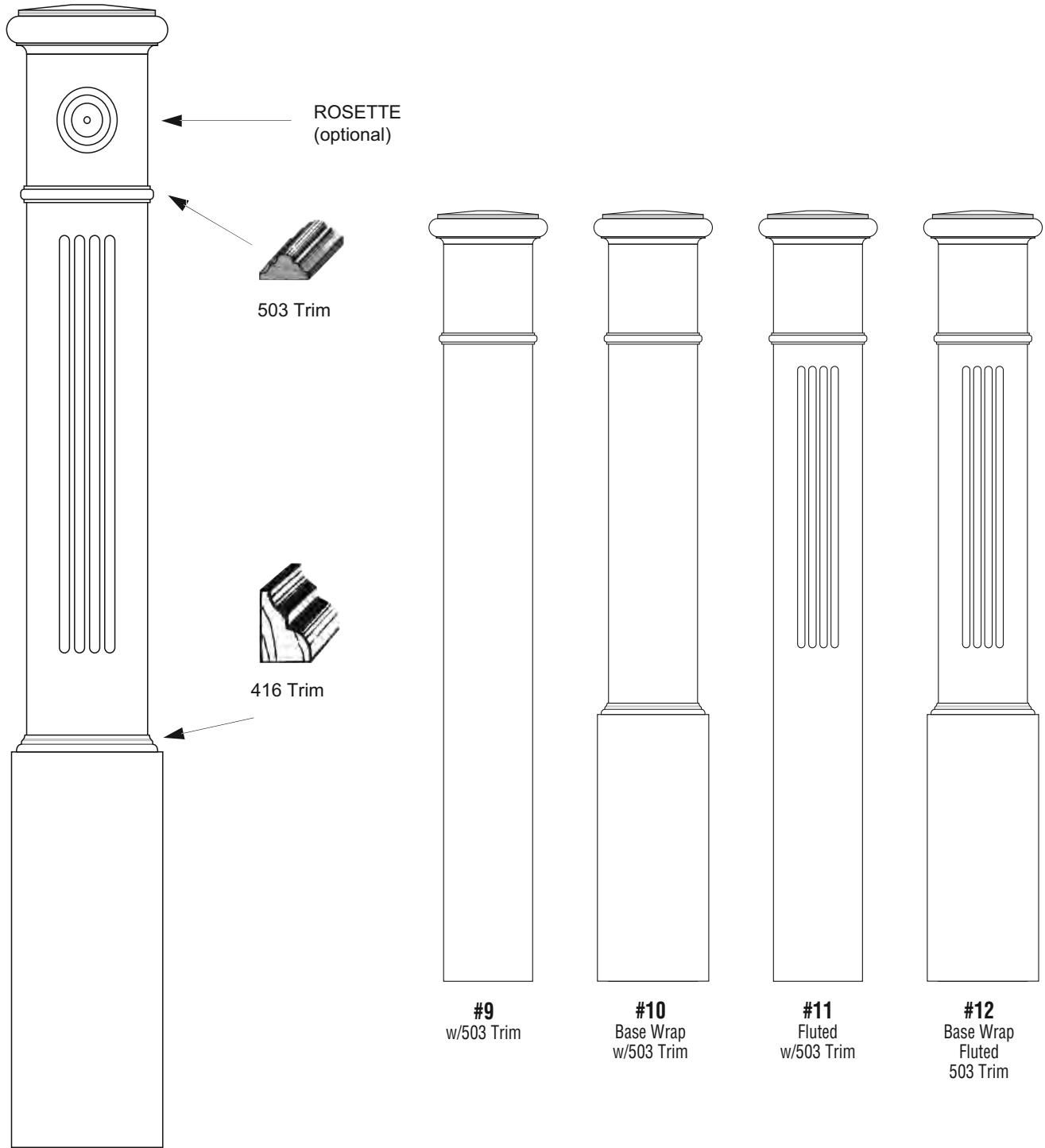

Unattached Base Wrap and Trim Available  
Rosette Optional  
Drawings not to Scale

# BOX NEWELS

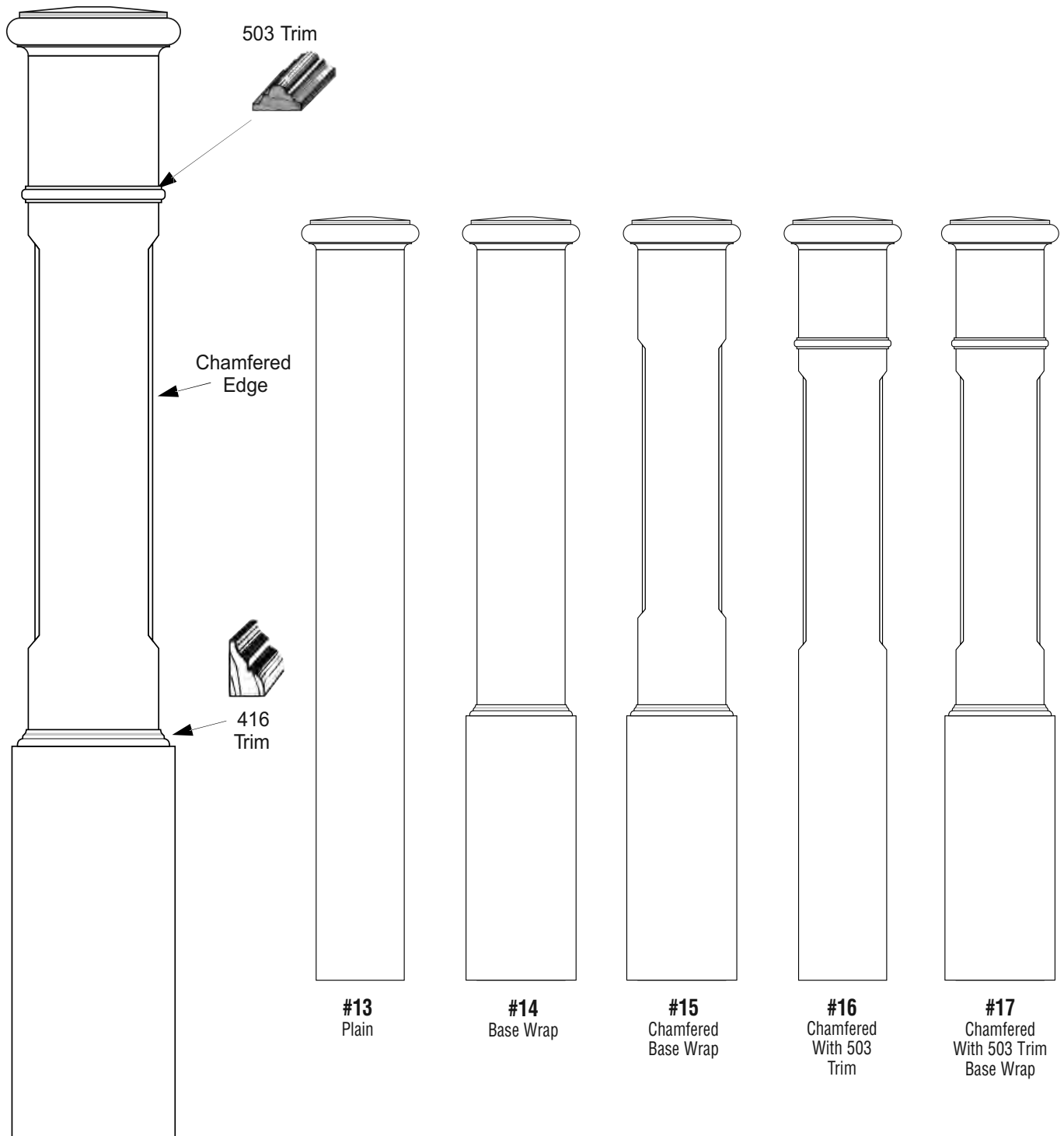

Unattached Base Wrap and Trim Available  
Drawing not to Scale

# BOX NEWELS

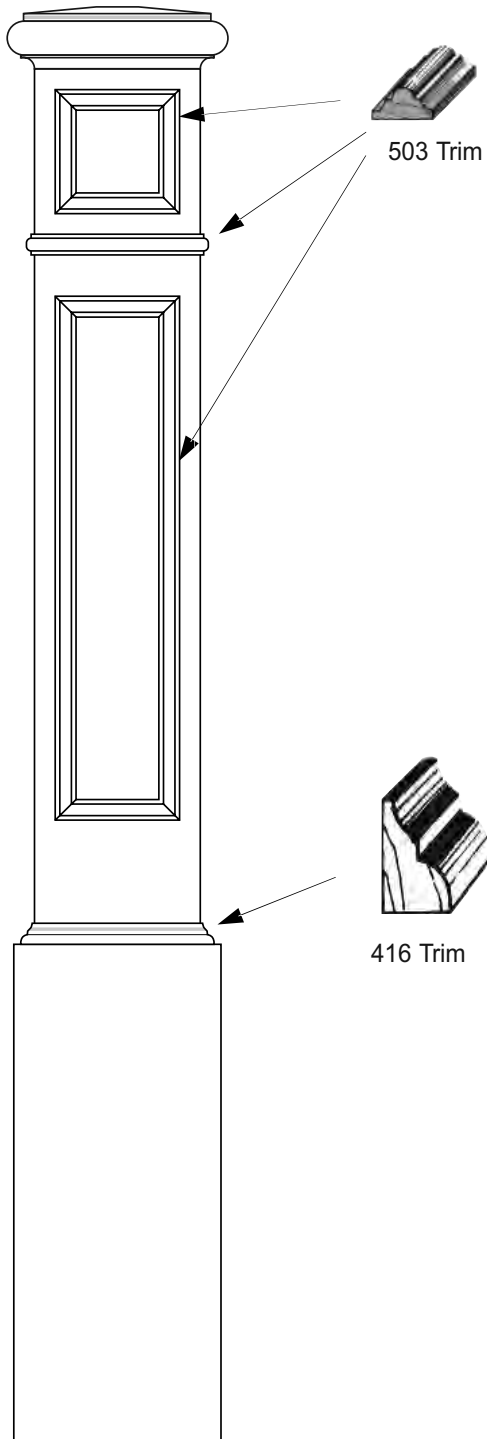

Unattached Base Wrap and Trim Available  
Drawings not to Scale

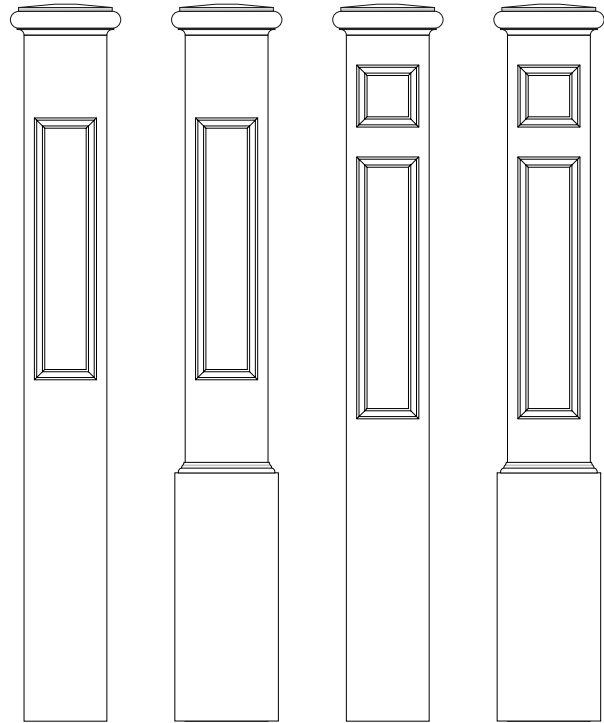

**#18** Lower Plant-on  
**#19** Lower Plant-on/  
Base Wrap  
**#20** Upper & Lower  
Plant-on  
**#21** Upper & Lower  
Plant-on/  
Base Wrap

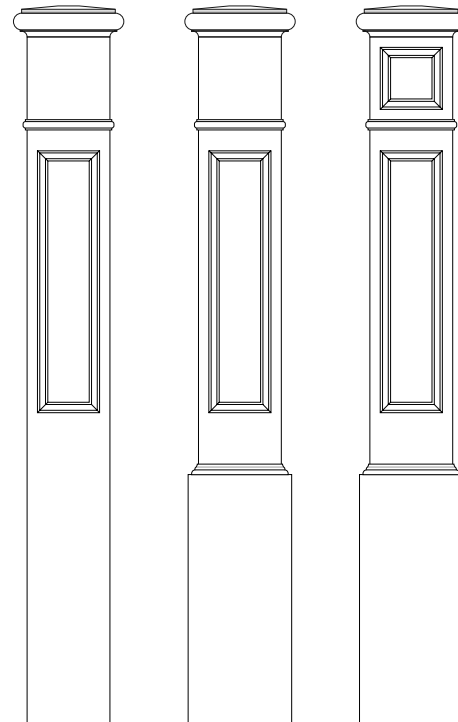

**#22** Lower  
Plant-on With  
503 Trim  
**#23** Lower Plant-on/  
Base Wrap  
503 Trim  
**#24** Upper & Lower  
Plant-on/Base Wrap  
503 Trim

# BOX NEWELS

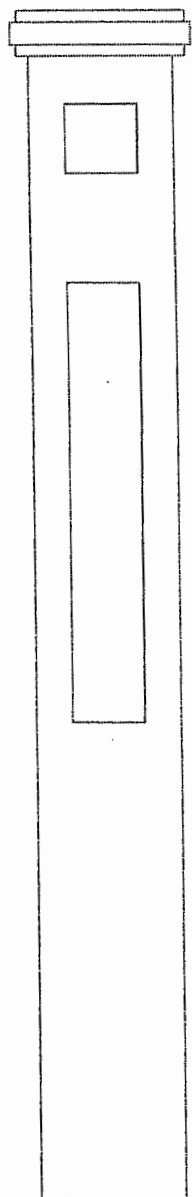

**#25**  
Shaker

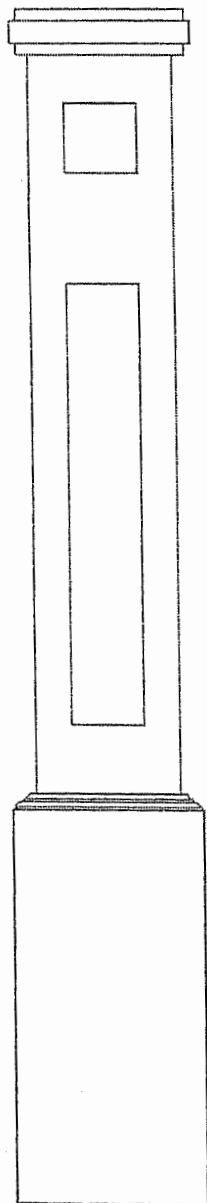

**#26**  
Shaker  
w/ Base Wrap

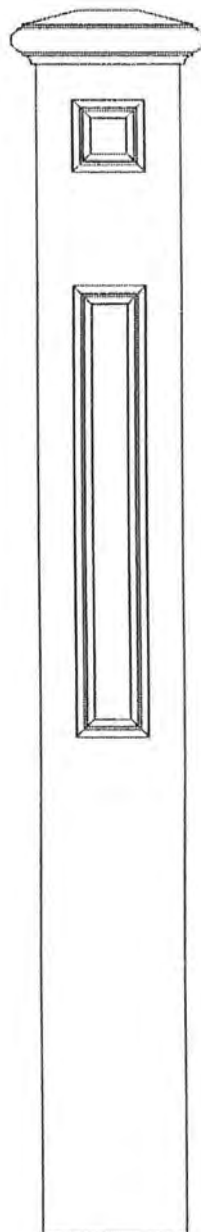

**#27**  
416 Trim

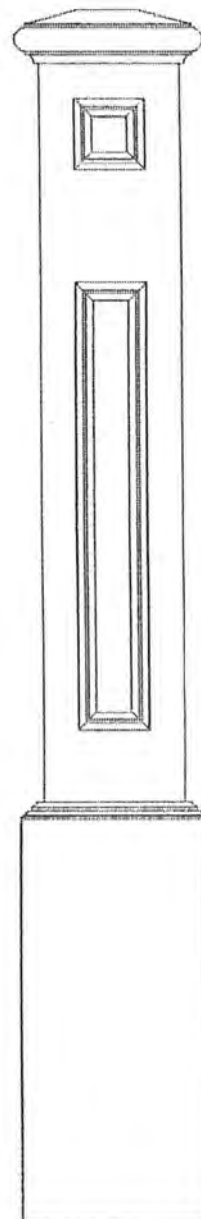

**#28**  
416 Trim  
w/Base Wrap