



The Finishing Touch

Classic Collection	1	Style 45	19
Express Series	2	Style 46	20
Base & Case	4	Style 47	20
SP303B-SP303C	4	Style 48	21
B205-C305	4	Style 49	21
B206(A)-C306	4	Style 50	22
B207-C307	5	Style 52	23
B208-C308	5	Style 53	23
B209-C309	6	Style 54	23
B211(A)-C311(A)	6	Style 55	24
B223	6	Style 56	24
C314	7	Style 57	25
C315	7	Style 58	26
C316	7	Style 59	27
C317	7	Header	28
C318	7	C390	28
C319	7	C391	28
C380	7	C392	28
C381	7	C392.6	28
B224(5)(6)-C324-C326(A)	8	Style 90	29
B225(5)-C325	8	Style 95	29
SPB228(4.5)-SPC328	8	Style 96	30
B235-C335	9	Style 97	30
B236-C336(A)(B)	9	Style 98	30
C339	9	Crown	31
B238-C338	10	E570	31
C341	10	E572	31
C344	10	E573	31
B245-C345	10	E574	31
B256-C356	11	E575	31
B257-C357	11	E576	31
B260-C360	11	E586	32
B263-C363	12	E587	32
B256(A)-C365	12	E588	32
C368	13	E589	32
C370	13	E591	32
B272-C372	13	E593	33
B273-C373	13	Style 71	34
B274-C374	14	Style 72	35
B275(A)-C375(A)	14	Style 73	36
B285-C385	14	Style 75	37
C382	15	Style 77	38
B294(A)-C394	15	Style 78	39
B295(A)-C395	15	Style 79	40
C396	15	Panel Molds/BeadBoard	41
Style 31	16	Cove Mold	41
Style 32	16	Window Sill Material	43
Style 33	17	BeadBoard Panels	44
Style 34	17	Astrigal/Chair Rail	45
Style 36	17	Plinth/Corner Block	46
Style 37	18	Flat Stock	48
Style 38	18	Door & Window Material	49
Style 39	18		
Style 42	19		
Style 43	19		



RG338
 $\frac{9}{16} \times 2\frac{7}{8}$
 In Stock

RG238
 $\frac{1}{2} \times 4$
 In Stock



RG365
 $\frac{9}{16} \times 2\frac{7}{8}$
 In Stock

RG265
 $\frac{1}{2} \times 4$
 In Stock



RG336
 $\frac{9}{16} \times 2\frac{7}{8}$
 In Stock

RG236
 $\frac{1}{2} \times 4$
 In Stock



RG303
 $\frac{9}{16} \times 2\frac{7}{8}$
 In Stock

RG203
 $\frac{1}{2} \times 4$
 In Stock



RG360
 $\frac{9}{16} \times 2\frac{7}{8}$
 In Stock

RG260
 $\frac{1}{2} \times 4$
 In Stock



RG324
 $\frac{9}{16} \times 2\frac{7}{8}$
 In Stock

RG224
 $\frac{1}{2} \times 4$
 In Stock



C103
 $\frac{3}{4} \times 3$
In Stock



C113
 $\frac{3}{4} \times 3$
In Stock



C123
 $\frac{3}{4} \times 3$
In Stock



C133
 $\frac{3}{4} \times 3$
In Stock



B104.5
 $\frac{5}{8} \times 4\frac{1}{2}$
In Stock



B114.5
 $\frac{5}{8} \times 4\frac{1}{2}$
In Stock



B124.5
 $\frac{5}{8} \times 4\frac{1}{2}$
In Stock



B134.5
 $\frac{5}{8} \times 4\frac{1}{2}$
In Stock



C143
 $\frac{3}{4} \times 3$
In Stock



C163
 $\frac{3}{4} \times 3$
In Stock



C173
 $\frac{3}{4} \times 3$
In Stock



C192.75
 $1 \times 2\frac{3}{4}$
In Stock



B144.5
 $\frac{5}{8} \times 4\frac{1}{2}$
In Stock



B164.5
 $\frac{5}{8} \times 4\frac{1}{2}$
In Stock



B174.5
 $\frac{5}{8} \times 4\frac{1}{2}$
In Stock



B194.5
 $\frac{5}{8} \times 4\frac{1}{2}$
In Stock



SP303B
 $\frac{9}{16} \times 5\frac{3}{4}$
In Stock



SP303C
 $\frac{3}{4} \times 3\frac{1}{4}$
In Stock



B205
 $\frac{1}{2} \times 3\frac{1}{2}$
Not In Stock



C305
 $\frac{1}{2} \times 2\frac{3}{4}$
Not In Stock



B206
 $\frac{1}{2} \times 4$
In Stock

B206A
 $\frac{1}{2} \times 5$
In Stock



C306
 $\frac{5}{8} \times 2\frac{3}{4}$
In Stock



B207
5/8 X 5
Not In Stock



C307
3/4 X 3
Not In Stock



B208
3/4 X 7
In Stock



C308
1 X 4 1/2
In Stock



B209
 $\frac{3}{4} \times 4\frac{1}{4}$
Not In Stock



C309
 $\frac{3}{4} \times 2\frac{5}{8}$
Not In Stock



B211
 $\frac{5}{8} \times 4\frac{1}{4}$
In Stock
B211A
 $\frac{5}{8} \times 5\frac{1}{4}$
In Stock



C311
 $\frac{3}{4} \times 3$
In Stock
C311A
 $\frac{5}{8} \times 3\frac{1}{4}$
Not In Stock



C312
 $\frac{1}{2} \times 2\frac{1}{4}$
Not In Stock



B223
 $\frac{3}{4} \times 5\frac{1}{4}$
Not In Stock



C314
 $\frac{3}{4} \times 3\frac{3}{4}$
Not In Stock



C315
 $\frac{3}{4} \times 3\frac{1}{2}$
In Stock



C316
 $\frac{3}{4} \times 3\frac{1}{4}$
In Stock



C317
 $\frac{3}{4} \times 3\frac{1}{4}$
Not In Stock



C318
 $\frac{3}{4} \times 2\frac{1}{2}$
Not In Stock



C319
 $\frac{1}{2} \times 2\frac{1}{4}$
In Stock



C380
 $\frac{5}{8} \times 3\frac{1}{8}$
Not In Stock



C381
 $\frac{3}{4} \times 4$
Not In Stock



C324
 $\frac{5}{8} \times 3$
In Stock



C326
 $\frac{5}{8} \times 3$
In Stock

C326A
 $\frac{5}{8} \times 3\frac{1}{2}$
In Stock



B224
 $\frac{1}{2} \times 4$
In Stock

B224-5
 $\frac{1}{2} \times 5$
In Stock

B224-6
 $\frac{1}{2} \times 6$
In Stock

B225
 $\frac{1}{2} \times 4$
In Stock

B225-5
 $\frac{1}{2} \times 5$
In Stock



C325
 $\frac{5}{8} \times 3$
In Stock



SPB2284.5
 $\frac{1}{2} \times 4\frac{1}{2}$
Not In Stock

SPB228
 $\frac{1}{2} \times 5$
Not In Stock



SPC328
 $\frac{5}{8} \times 3\frac{1}{4}$
Not In Stock

Not Shown

B228	$\frac{1}{2} \times 3\frac{1}{4}$	Not in Stock
C328	$\frac{5}{8} \times 2\frac{1}{4}$	Not in Stock

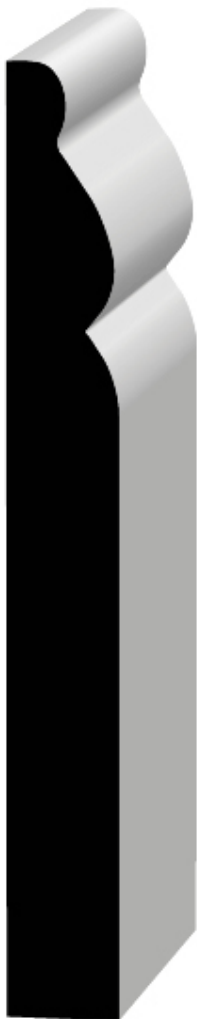

B235
 $\frac{5}{8} \times 5\frac{1}{4}$
In Stock



C335
 $\frac{5}{8} \times 3\frac{1}{4}$
In Stock



B236
 $\frac{9}{16} \times 6$
In Stock



C336B
 $\frac{3}{4} \times 3\frac{1}{2}$
In Stock



C336
 $1\frac{1}{16} \times 4$
Not In Stock

C336A
 $1\frac{1}{16} \times 3\frac{1}{4}$
Not In Stock



C339
 $\frac{5}{8} \times 3\frac{1}{8}$
In Stock

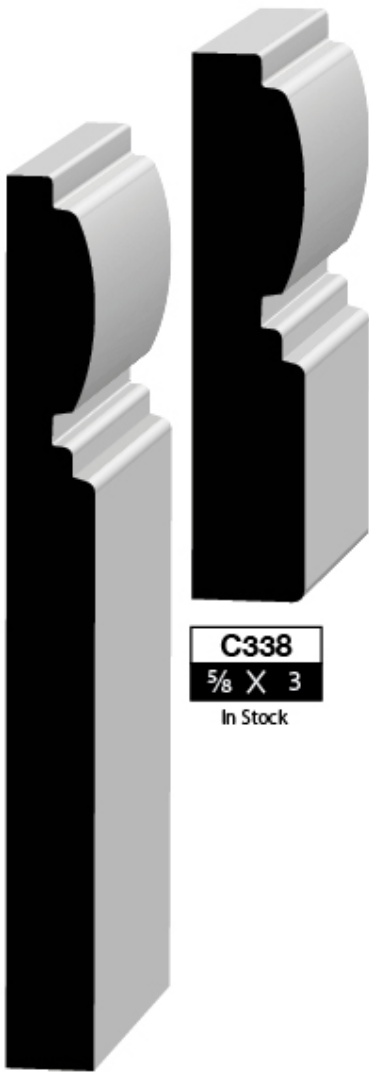

B238
 $\frac{1}{2} \times 5$
In Stock



C338
 $\frac{5}{8} \times 3$
In Stock



C341
 $\frac{5}{8} \times 3\frac{3}{8}$
Not In Stock



C344
 $\frac{3}{4} \times 3$
In Stock



B245
 $\frac{3}{4} \times 5\frac{1}{2}$
In Stock



C345
 $\frac{3}{4} \times 3\frac{1}{2}$
In Stock



B256
 $\frac{3}{8} \times 3\frac{1}{4}$
In Stock



C356
 $\frac{1}{2} \times 2\frac{1}{4}$
In Stock



B257
 $\frac{3}{8} \times 3\frac{1}{4}$
In Stock



C357
 $\frac{1}{2} \times 2\frac{1}{4}$
In Stock



B260
 $\frac{5}{8} \times 5\frac{1}{2}$
In Stock



C360
 $\frac{3}{4} \times 3\frac{1}{2}$
In Stock



B263
 $\frac{5}{8} \times 5\frac{3}{4}$
In Stock



C363
 $\frac{3}{4} \times 3\frac{1}{2}$
In Stock



B265
 $\frac{5}{8} \times 6\frac{1}{2}$
In Stock



B265A
 $\frac{5}{8} \times 6\frac{1}{2}$
In Stock



C365
 $\frac{3}{4} \times 3\frac{1}{2}$
In Stock



C368
 $\frac{3}{4} \times 4\frac{3}{4}$
Not In Stock



C370
 $\frac{3}{4} \times 3\frac{3}{4}$
In Stock



B272
 $\frac{9}{16} \times 4\frac{1}{8}$
In Stock



C372
 $\frac{5}{8} \times 3\frac{1}{4}$
In Stock



B273
 $\frac{5}{8} \times 5$
Not In Stock



C373
 $\frac{3}{4} \times 2\frac{7}{8}$
Not In Stock



B274
 $\frac{5}{8} \times 5\frac{3}{4}$
In Stock



C374
 $\frac{3}{4} \times 3\frac{1}{4}$
In Stock



B275
 $\frac{5}{8} \times 5$
In Stock

B275A
 $\frac{5}{8} \times 4$
Not In Stock



C375
 $\frac{5}{8} \times 2\frac{1}{2}$
In Stock

C375A
 $\frac{5}{8} \times 3\frac{1}{4}$
In Stock



B285
 $\frac{9}{16} \times 4\frac{3}{4}$
In Stock

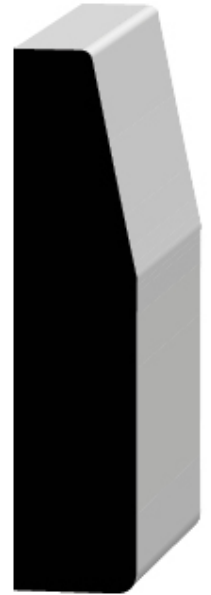

C385
 $1\frac{1}{16} \times 3$
In Stock



C382
1 X 6
In Stock



B294
 $\frac{9}{16}$ X $4\frac{3}{4}$
In Stock

B294A
 $\frac{9}{16}$ X $5\frac{3}{4}$
In Stock



C394
 $\frac{5}{8}$ X $3\frac{1}{4}$
In Stock



B295
 $\frac{9}{16}$ X $2\frac{3}{4}$
Not In Stock

B295A
 $\frac{9}{16}$ X $3\frac{1}{4}$
Not In Stock



C395
 $\frac{5}{8}$ X $2\frac{1}{4}$
Not In Stock



C396
 $\frac{9}{16}$ X $3\frac{1}{4}$
In Stock

Not Shown		
C312	$\frac{9}{16}$ X $2\frac{15}{16}$	Not In Stock
B412	$\frac{1}{2}$ X $4\frac{1}{4}$	Not In Stock
B512	$\frac{1}{2}$ X $5\frac{1}{4}$	Not In Stock

Style 31

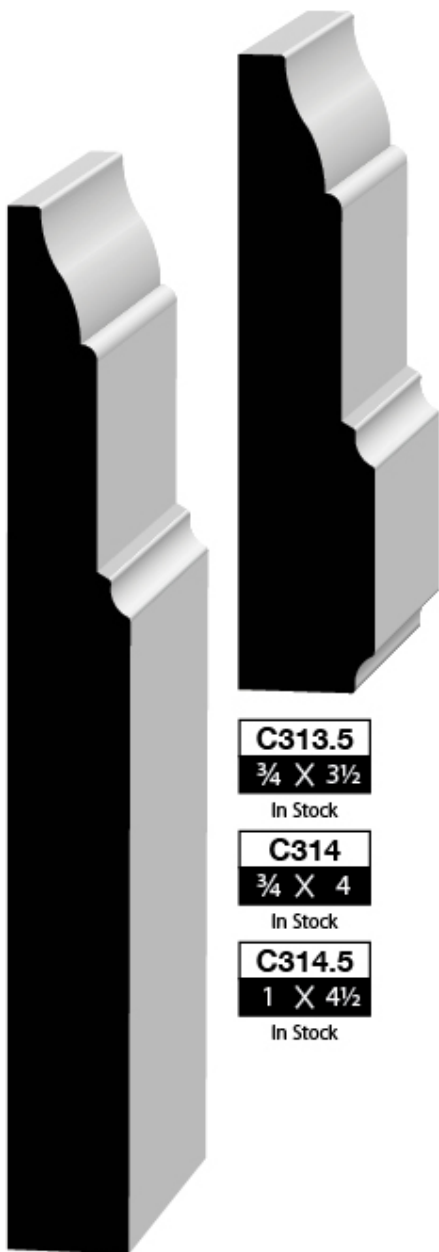

C313.5

$\frac{3}{4} \times 3\frac{1}{2}$

In Stock

C314

$\frac{3}{4} \times 4$

In Stock

C314.5

$1 \times 4\frac{1}{2}$

In Stock

B316

$\frac{5}{8} \times 5\frac{3}{4}$

In Stock

B318

$\frac{5}{8} \times 7\frac{7}{8}$

In Stock

Style 32

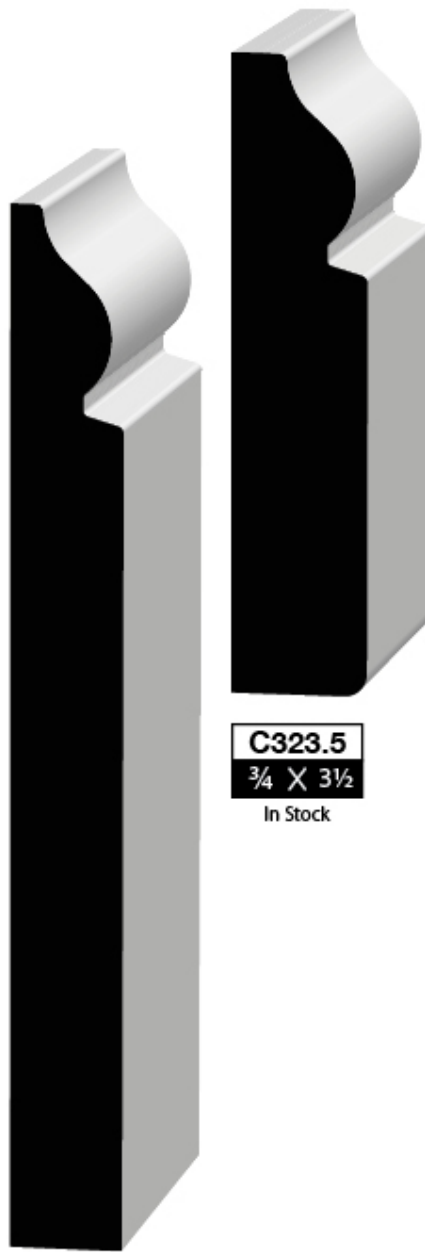

C323.5

$\frac{3}{4} \times 3\frac{1}{2}$

In Stock

B326

$\frac{5}{8} \times 5\frac{3}{4}$

In Stock

B328

$\frac{5}{8} \times 7\frac{7}{8}$

In Stock

Style 33

Style 34

Style 36

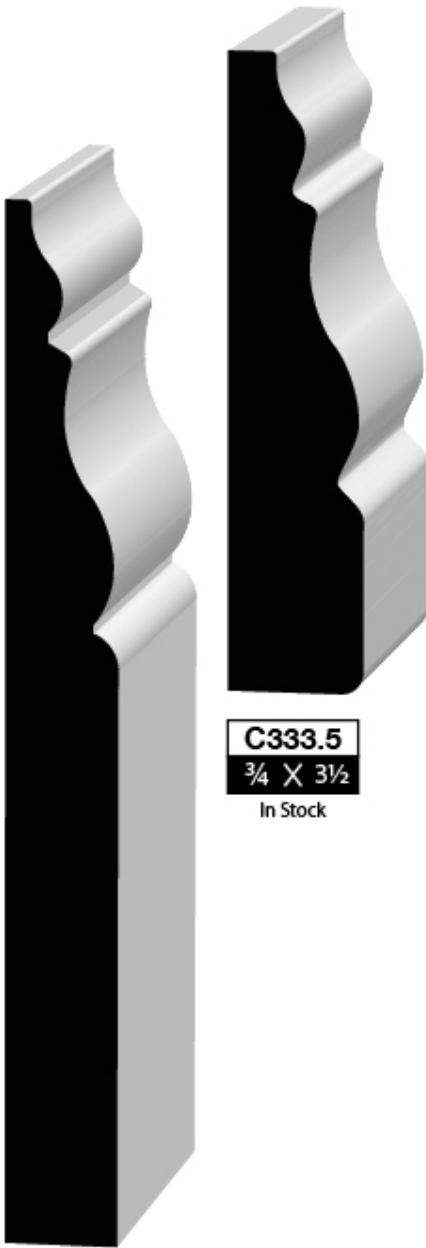

C333.5
 $\frac{3}{4} \times 3\frac{1}{2}$
 In Stock

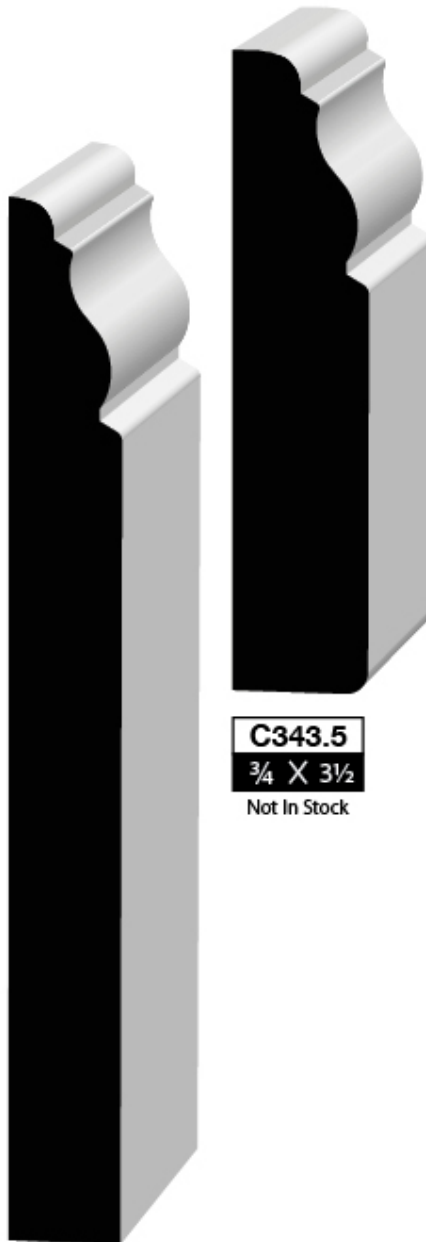

C343.5
 $\frac{3}{4} \times 3\frac{1}{2}$
 Not In Stock



C363.5
 $\frac{3}{4} \times 3\frac{1}{2}$
 Not In Stock

B336
 $\frac{5}{8} \times 5\frac{3}{4}$
 In Stock

B338
 $\frac{5}{8} \times 7\frac{1}{8}$
 In Stock

B346
 $\frac{5}{8} \times 5\frac{3}{4}$
 Not In Stock

B348
 $\frac{5}{8} \times 7\frac{1}{8}$
 Not In Stock

B366
 $\frac{5}{8} \times 5\frac{3}{4}$
 Not In Stock

B368
 $\frac{5}{8} \times 7\frac{1}{8}$
 Not In Stock

Style 37



C373.5
 $\frac{3}{4} \times 3\frac{1}{2}$
In Stock

B376
 $\frac{5}{8} \times 5\frac{3}{4}$
In Stock

B378
 $\frac{5}{8} \times 7\frac{1}{8}$
Not In Stock

Style 38



C383.5
 $\frac{3}{4} \times 3\frac{1}{2}$
Not In Stock

B386
 $\frac{5}{8} \times 5\frac{3}{4}$
Not In Stock

B388
 $\frac{5}{8} \times 7\frac{1}{8}$
Not In Stock

Style 39

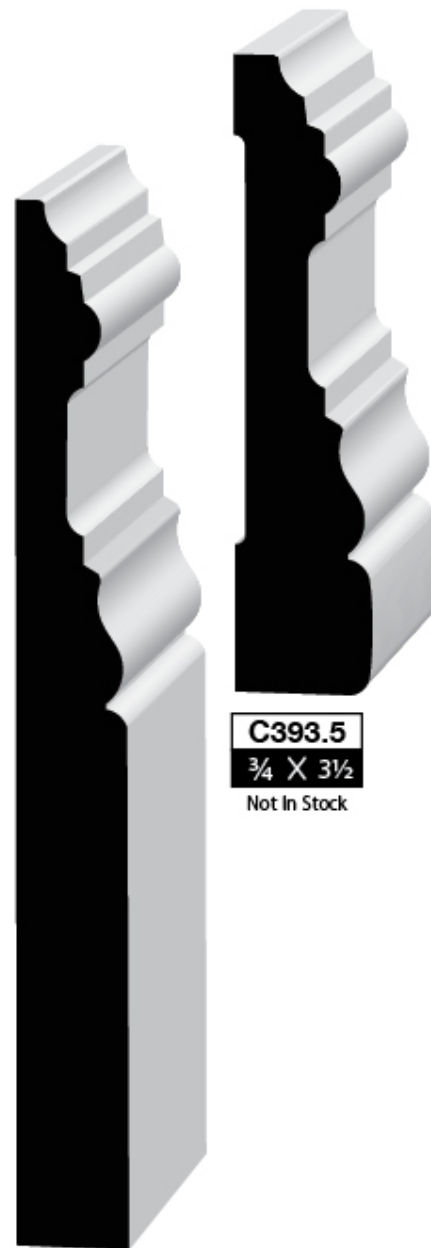

C393.5
 $\frac{3}{4} \times 3\frac{1}{2}$
Not In Stock

B396
 $\frac{5}{8} \times 5\frac{3}{4}$
Not In Stock

B398
 $\frac{5}{8} \times 7\frac{1}{8}$
Not In Stock

Style 42

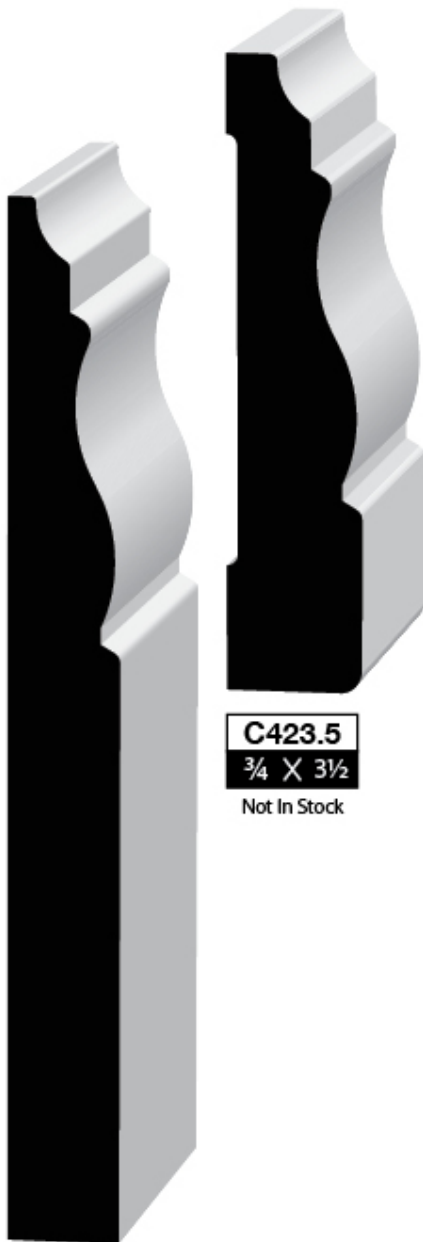

C423.5
 $\frac{3}{4} \times 3\frac{1}{2}$
 Not In Stock

B426
 $\frac{5}{8} \times 5\frac{3}{4}$
 Not In Stock

B428
 $\frac{5}{8} \times 7\frac{7}{8}$
 Not In Stock

Style 43



C433.5
 $\frac{3}{4} \times 3\frac{1}{2}$
 Not In Stock

B436
 $\frac{5}{8} \times 5\frac{3}{4}$
 Not In Stock

B438
 $\frac{5}{8} \times 7\frac{7}{8}$
 Not In Stock

Style 45

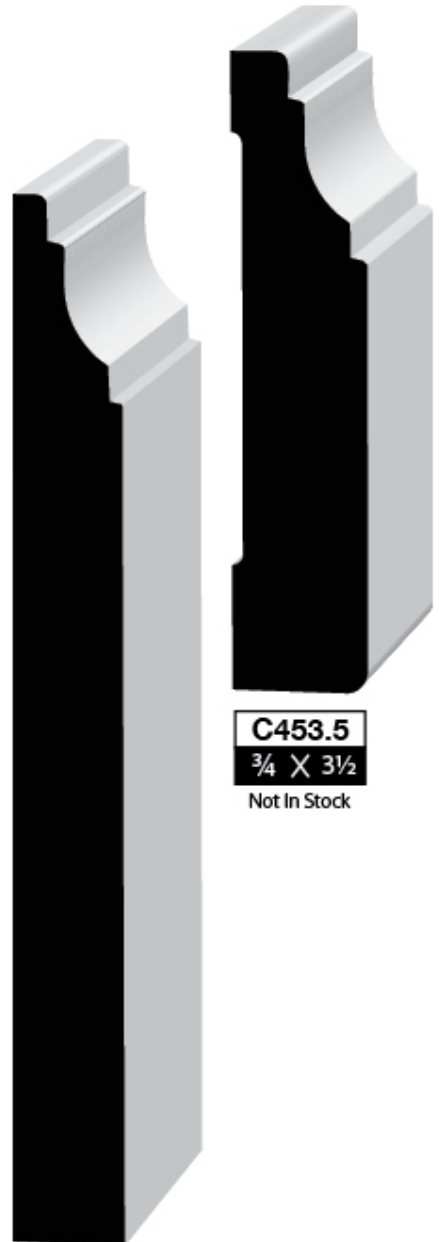

C453.5
 $\frac{3}{4} \times 3\frac{1}{2}$
 Not In Stock

B456
 $\frac{5}{8} \times 5\frac{3}{4}$
 Not In Stock

B458
 $\frac{5}{8} \times 7\frac{7}{8}$
 Not In Stock

Style 46

Style 46
Symmetrical

Style 47



C463.5
 $\frac{3}{4} \times 3\frac{1}{2}$
Not In Stock

C46S3.5
 $\frac{3}{4} \times 3\frac{1}{2}$
Not In Stock

C473.5
 $\frac{3}{4} \times 3\frac{1}{2}$
Not In Stock

B466
 $\frac{5}{8} \times 5\frac{3}{4}$
Not In Stock

B468
 $\frac{5}{8} \times 7\frac{7}{8}$
Not In Stock

B476
 $\frac{5}{8} \times 5\frac{3}{4}$
Not In Stock

B478
 $\frac{5}{8} \times 7\frac{7}{8}$
Not In Stock

Style 48

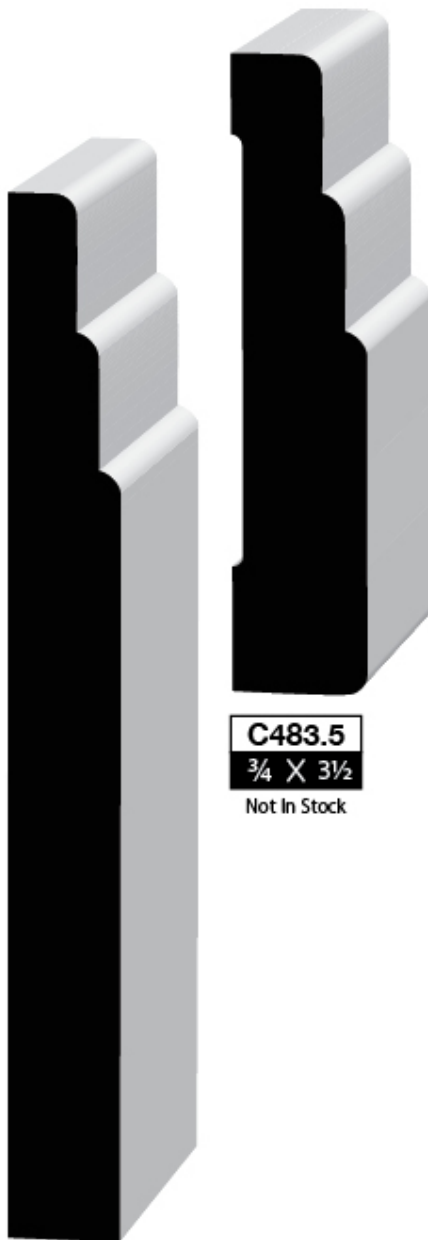

C483.5

$\frac{3}{4} \times 3\frac{1}{2}$

Not In Stock

B486

$\frac{5}{8} \times 5\frac{3}{4}$

Not In Stock

B488

$\frac{5}{8} \times 7\frac{7}{8}$

Not In Stock

Style 49

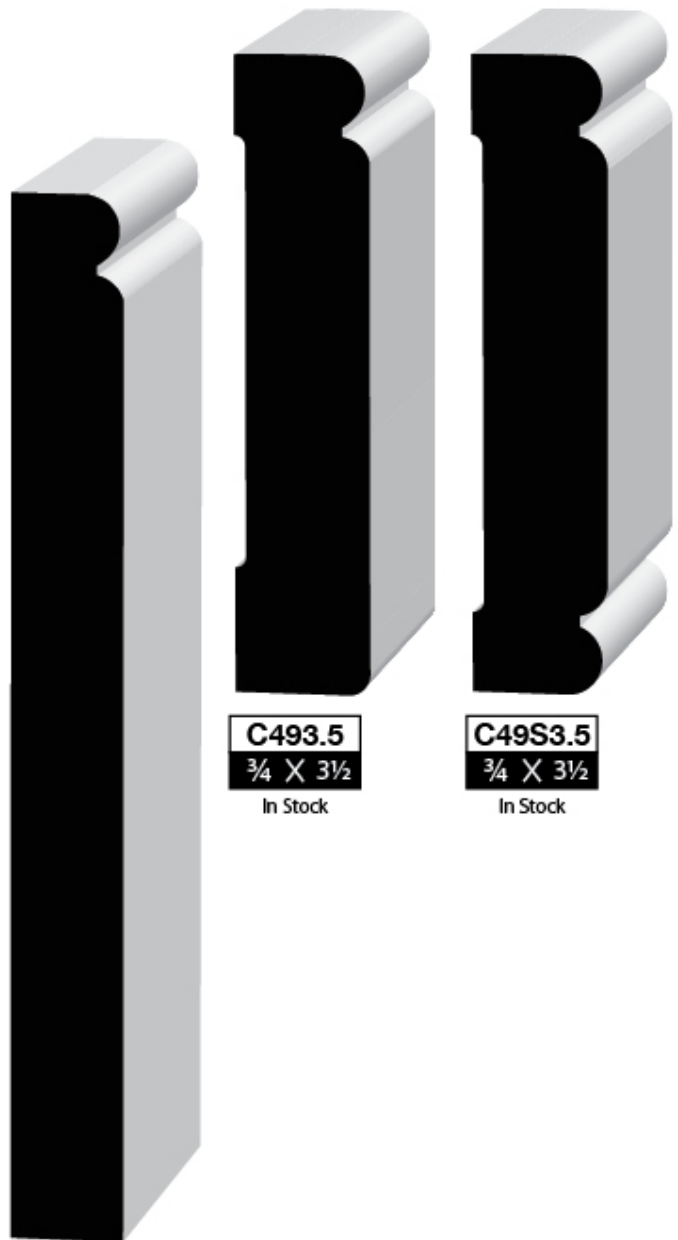

C493.5

$\frac{3}{4} \times 3\frac{1}{2}$

In Stock

C49S3.5

$\frac{3}{4} \times 3\frac{1}{2}$

In Stock

B496

$\frac{5}{8} \times 5\frac{3}{4}$

In Stock

B498

$\frac{5}{8} \times 7\frac{7}{8}$

In Stock

Style 49
Symmetrical

Style 50



B506
 $\frac{5}{8} \times 5\frac{3}{4}$
In Stock

B508
 $\frac{5}{8} \times 7\frac{7}{8}$
In Stock



C503.5
 $\frac{3}{4} \times 3\frac{1}{2}$
In Stock



C504.0
 $\frac{3}{4} \times 4$
In Stock



C505.0
 1×5
In Stock

Style 52



C523.5
 $\frac{3}{4} \times 3\frac{1}{2}$
Not In Stock

Style 53



C533.5
 $\frac{3}{4} \times 3\frac{1}{2}$
Not In Stock

Style 54

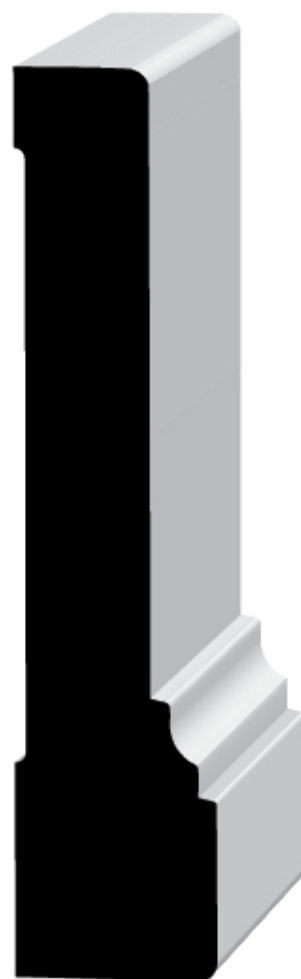

C545.0
 $1\frac{1}{8} \times 5$
Not In Stock



C544.25
 $1\frac{1}{8} \times 4\frac{1}{4}$
Not In Stock

Style 55

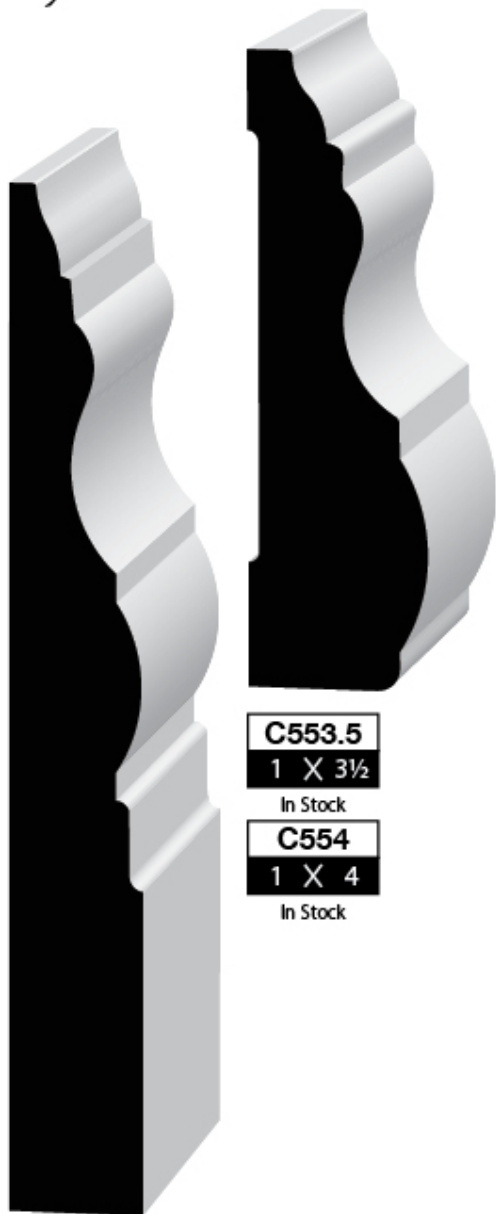

C553.5
1 X 3½
In Stock

C554
1 X 4
In Stock

B556
¾ X 5¾
In Stock

B558
¾ X 7⅞
In Stock

Style 56

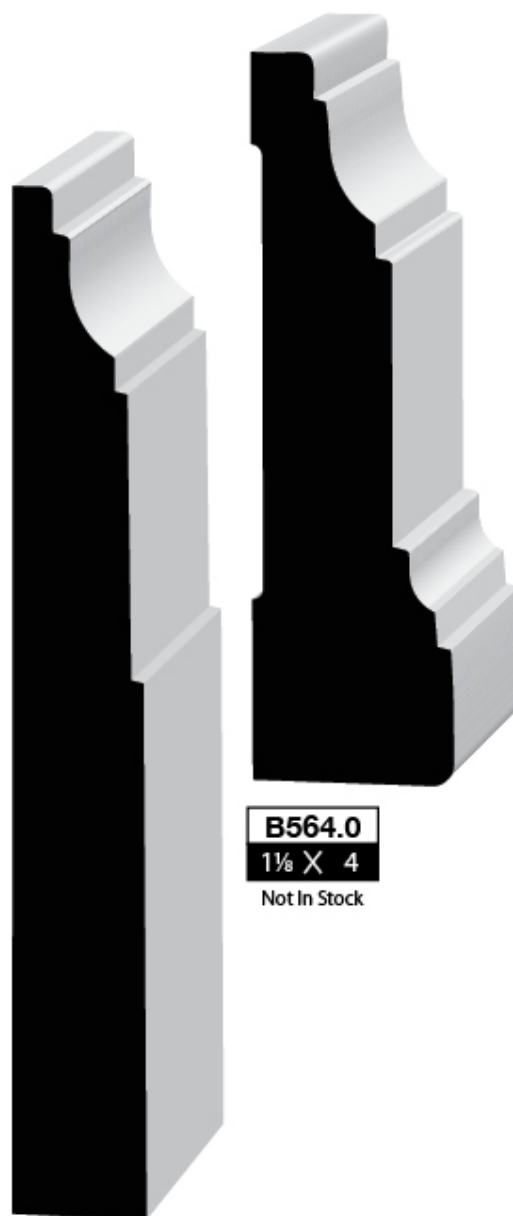

B564.0
1⅞ X 4
Not In Stock

B566
¾ X 5¾
Not In Stock

B568
¾ X 7⅞
Not In Stock

Style 57



B576
 $\frac{3}{4} \times 5\frac{3}{4}$
In Stock

B578
 $\frac{3}{4} \times 7\frac{1}{8}$
In Stock



C573.5
 $1\frac{1}{8} \times 3\frac{1}{2}$
In Stock



C574
 $1\frac{1}{8} \times 4$
In Stock



C575
 $1\frac{1}{4} \times 5$
Not In Stock

C576.5
 $1\frac{3}{8} \times 6\frac{1}{2}$
Not In Stock

Style 58



B588-1
1 X 7⁷/₈
Not In Stock



B588-75
3/4 X 7⁷/₈
Not In Stock



C585
1 3/4 X 5
Not In Stock



C584
1 5/16 X 4
Not In Stock

Not Shown		
C584.5	1 3/4 X 4 1/2	Not In Stock
C585.5	1 3/4 X 5 1/2	Not In Stock

Style 59

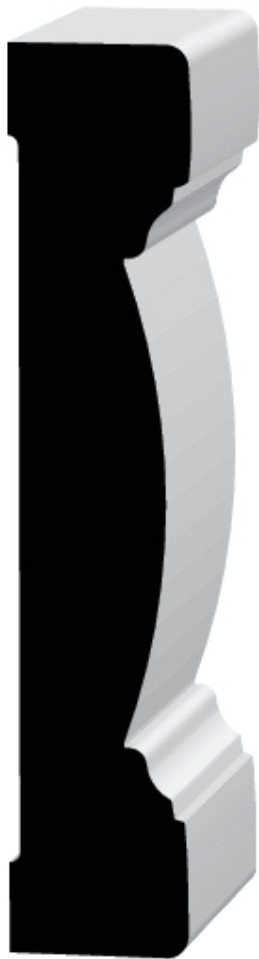

C595
1 X 5
Not In Stock



C594
3/4 X 4
Not In Stock

Chair Rail



CR613.25
5/8 X 3/4
Not In Stock



CR643.25
5/8 X 3/4
Not In Stock



CR653.25
5/8 X 3/4
Not In Stock



CR673.25
5/8 X 3/4
Not In Stock



C390
1 1/4 X 4 3/16
In Stock

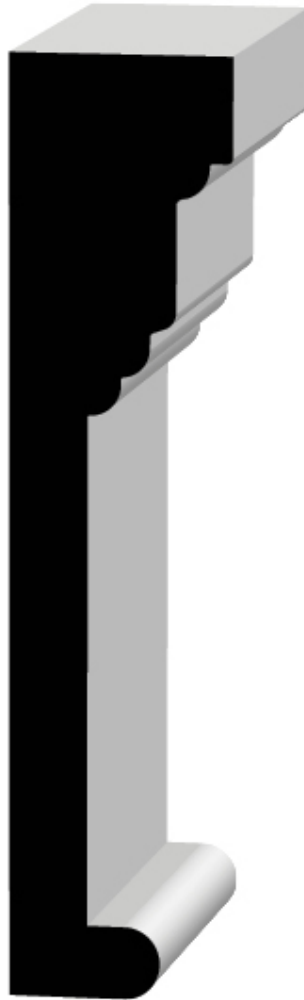

C391
1 1/4 X 5 1/4
In Stock

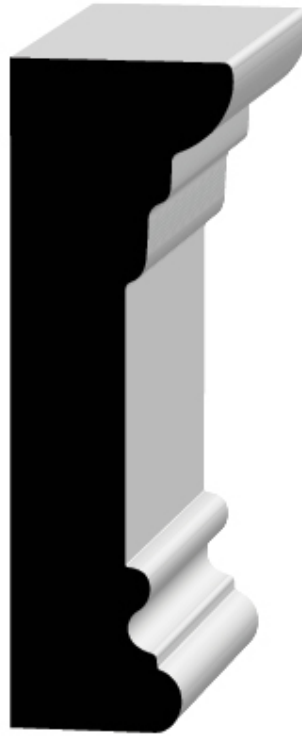

C392
1 1/4 X 3 3/4
In Stock

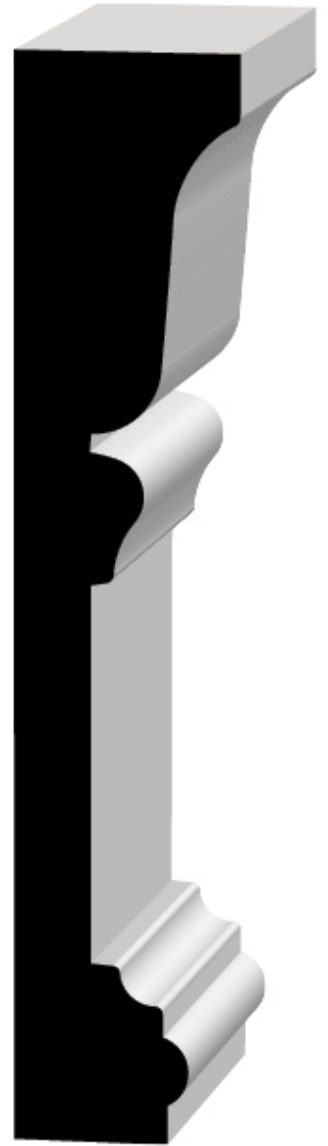

C392-6
1 1/4 X 6
In Stock

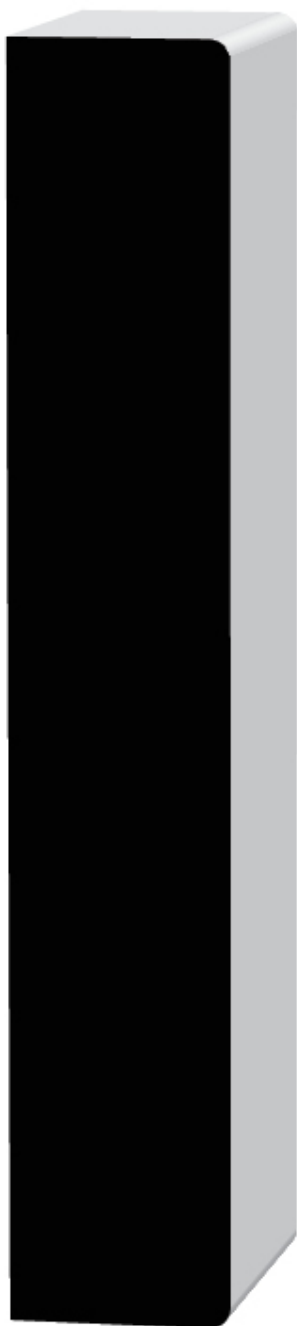

H907.25
1 1/4 X 7 1/4
Not In Stock



H906
1 X 5 3/4
In Stock



H956
1 X 5 3/4
In Stock



H954.5
1 X 4 1/2
In Stock



H964.5
1 X 4½
In Stock



H976
1 X 5¾
In Stock



H974.5
1 X 4½
In Stock



H986
1¼ X 5¾
In Stock

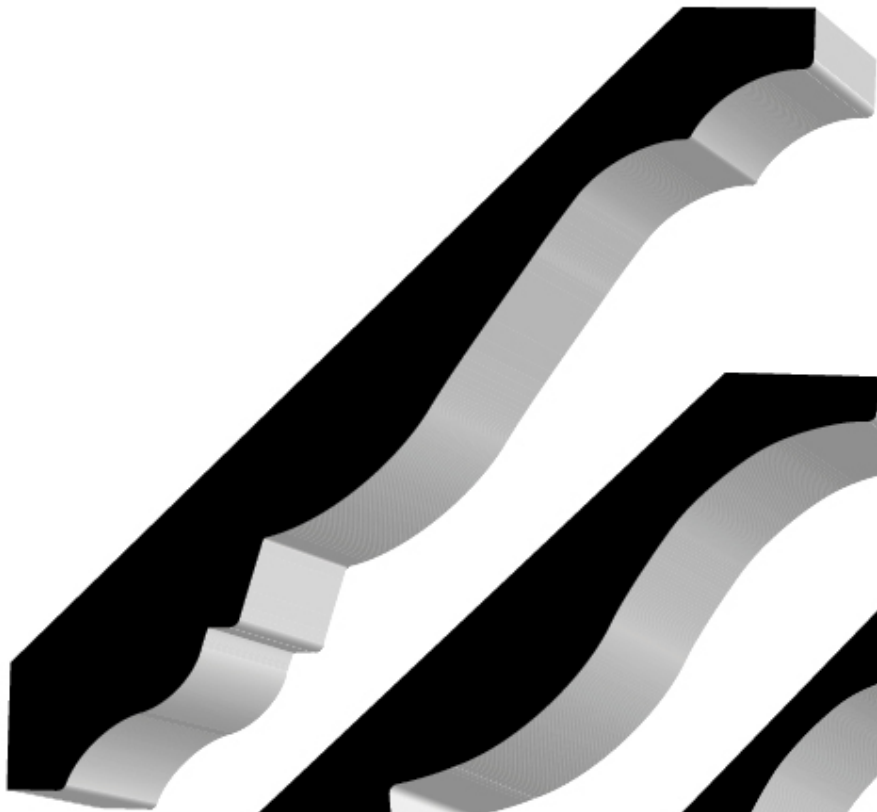

E576
 $\frac{3}{4} \times 6\frac{1}{8}$
In Stock



E575
 $\frac{3}{4} \times 5$
In Stock



E574
 $\frac{1}{2} \times 4\frac{1}{4}$
In Stock



E573
 $\frac{1}{2} \times 3\frac{1}{4}$
In Stock



E570
 $\frac{1}{2} \times 2\frac{1}{4}$
In Stock



E572
 $\frac{5}{8} \times 2\frac{1}{4}$
Not In Stock

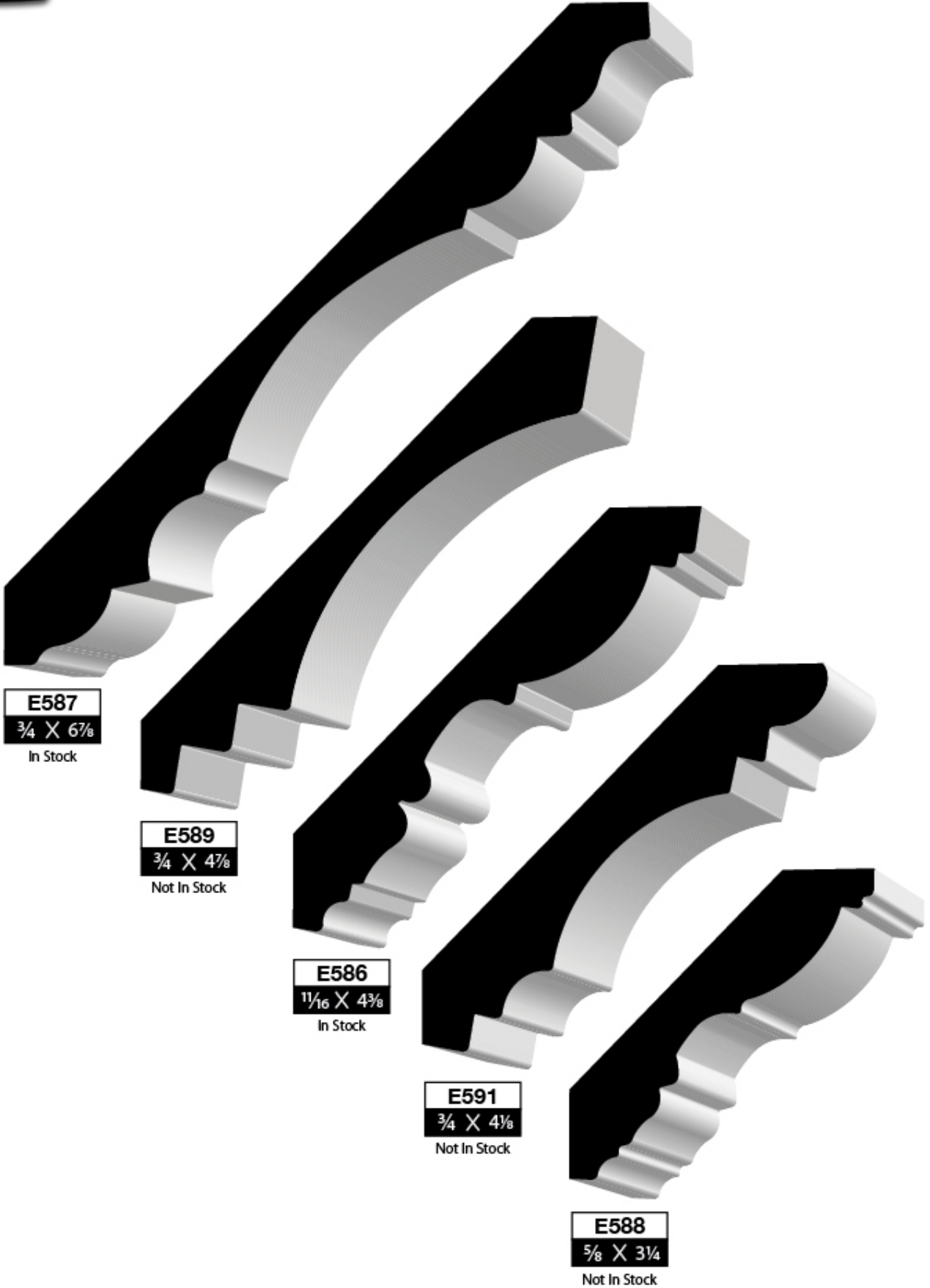

E587
 $\frac{3}{4} \times 6\frac{7}{8}$
In Stock

E589
 $\frac{3}{4} \times 4\frac{7}{8}$
Not In Stock

E586
 $1\frac{1}{16} \times 4\frac{3}{8}$
In Stock

E591
 $\frac{3}{4} \times 4\frac{1}{8}$
Not In Stock

E588
 $\frac{5}{8} \times 3\frac{1}{4}$
Not In Stock

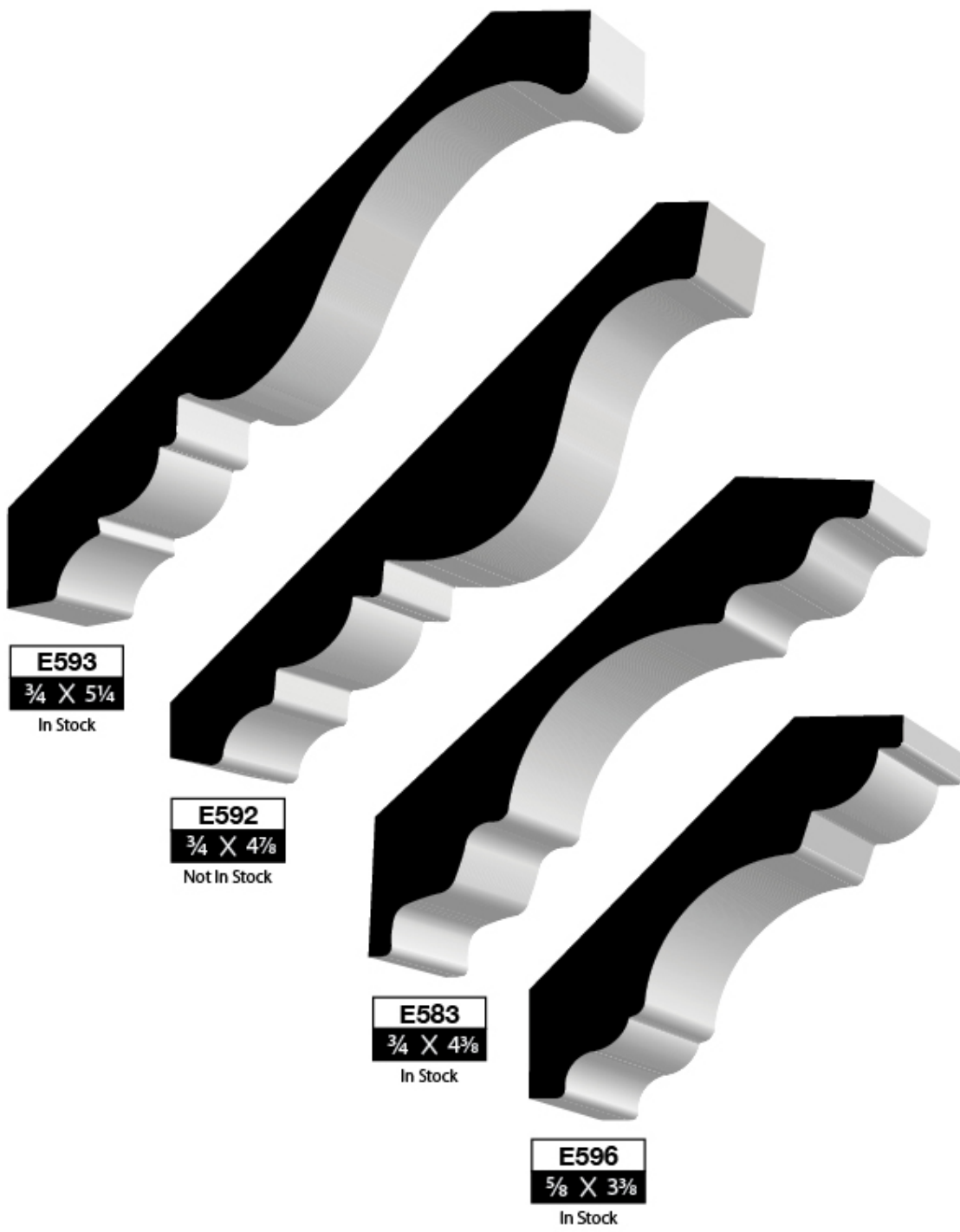

E593
 $\frac{3}{4} \times 5\frac{1}{4}$
In Stock

E592
 $\frac{3}{4} \times 4\frac{7}{8}$
Not In Stock

E583
 $\frac{3}{4} \times 4\frac{3}{8}$
In Stock

E596
 $\frac{5}{8} \times 3\frac{3}{8}$
In Stock

Style 71

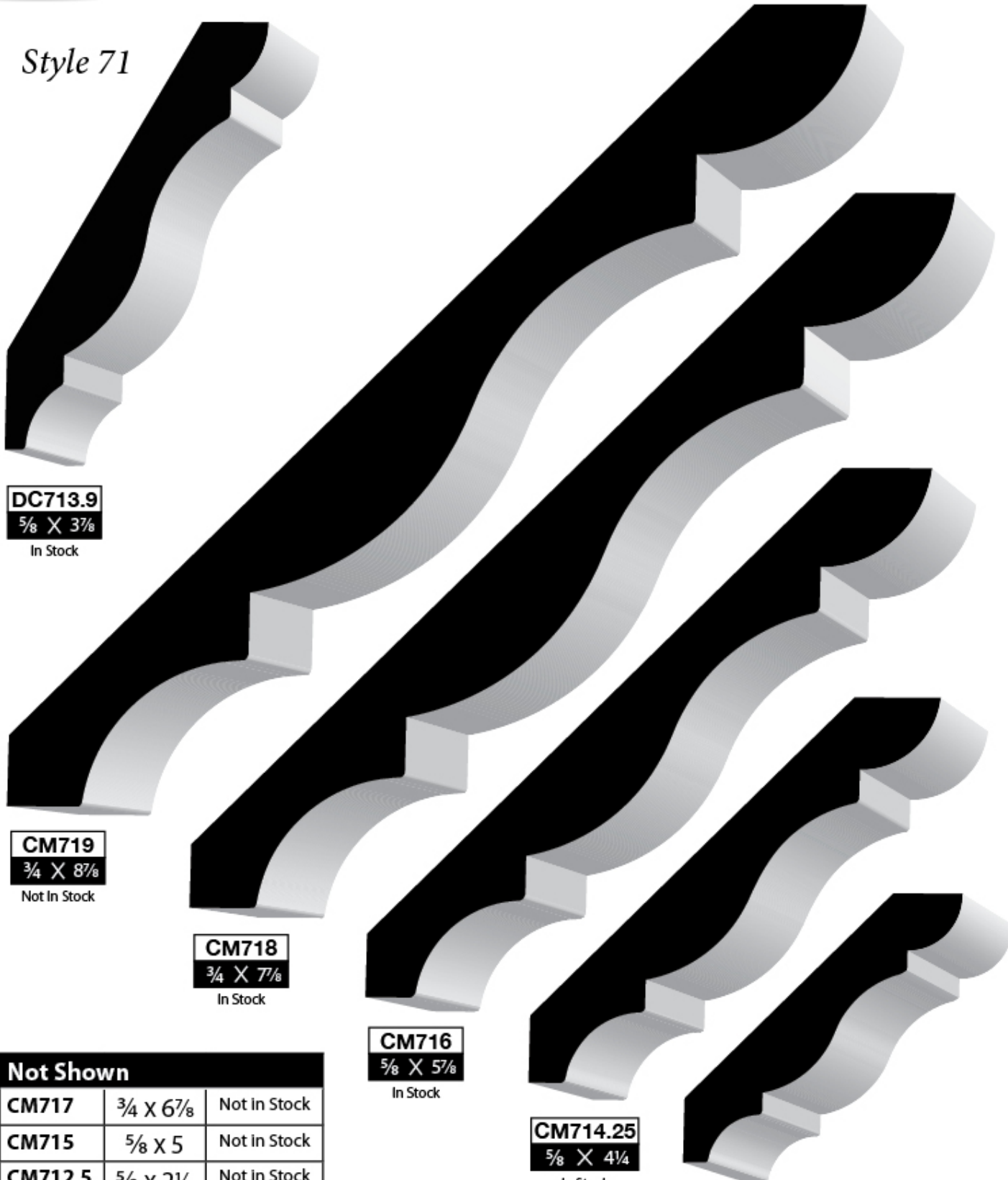

DC713.9
 $\frac{5}{8} \times 3\frac{7}{8}$

In Stock

CM719
 $\frac{3}{4} \times 8\frac{7}{8}$

Not In Stock

CM718
 $\frac{3}{4} \times 7\frac{1}{8}$

In Stock

CM716
 $\frac{5}{8} \times 5\frac{7}{8}$

In Stock

CM714.25
 $\frac{5}{8} \times 4\frac{1}{4}$

In Stock

CM713
 $\frac{5}{8} \times 3$

In Stock

Not Shown

CM717	$\frac{3}{4} \times 6\frac{7}{8}$	Not In Stock
CM715	$\frac{5}{8} \times 5$	Not In Stock
CM712.5	$\frac{5}{8} \times 2\frac{1}{2}$	Not In Stock

Style 72



DC723.9
5/8 X 37/8
In Stock

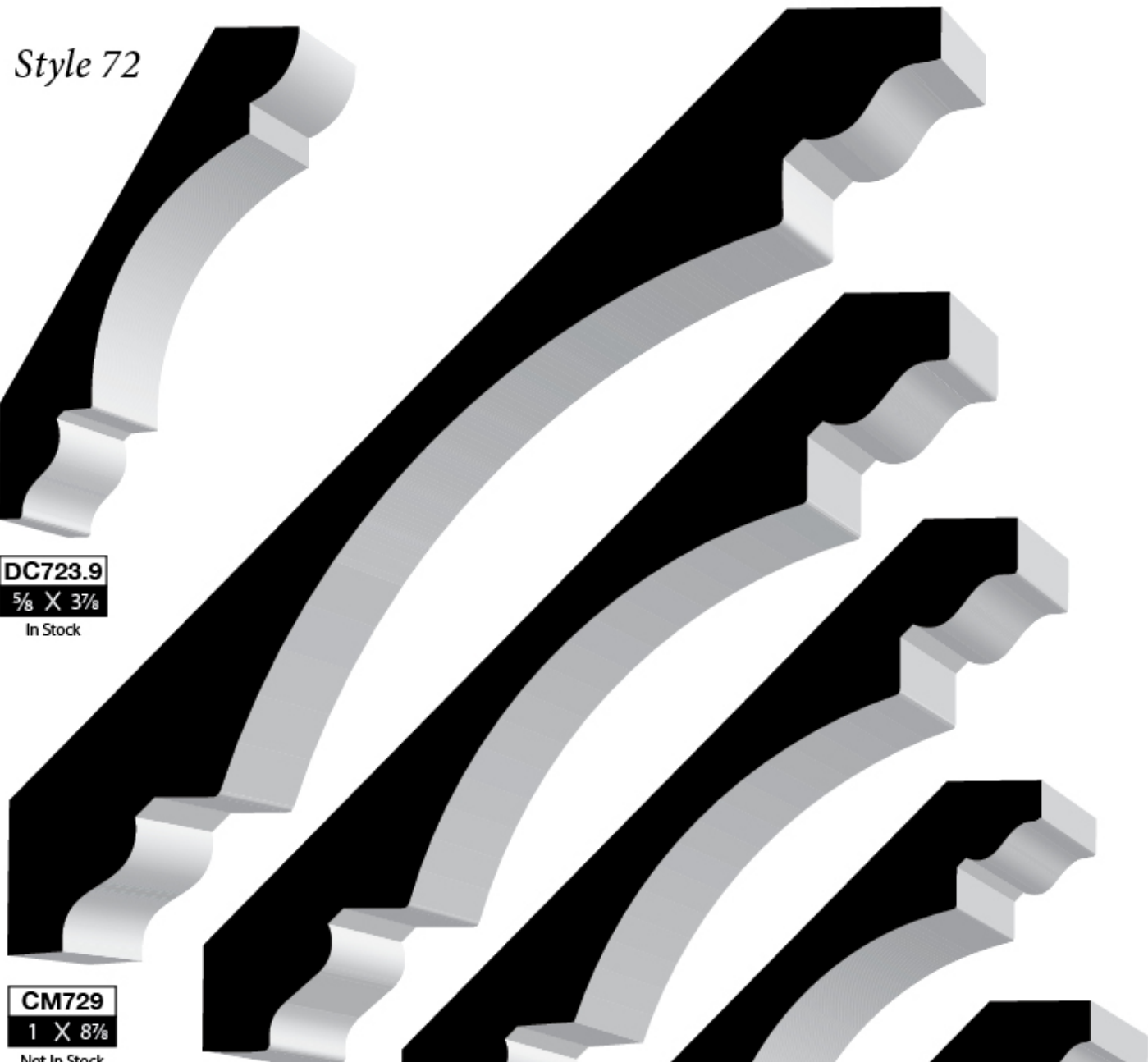

CM729
1 X 87/8
Not In Stock

CM727
3/4 X 67/8
Not In Stock

CM726
3/4 X 57/8
In Stock

CM724.25
5/8 X 4 1/4
In Stock

CM723
5/8 X 3
Not In Stock

Style 73

Not Shown		
CM737	$\frac{3}{4} \times 6\frac{7}{8}$	Not In Stock
CM734.25	$\frac{3}{4} \times 4\frac{1}{4}$	Not In Stock

CM739
 $\frac{3}{4} \times 8\frac{7}{8}$
Not In Stock

CM738
 $\frac{3}{4} \times 7\frac{7}{8}$
Not In Stock

CM736
 $\frac{3}{4} \times 5\frac{7}{8}$
In Stock

CM735
 $\frac{3}{4} \times 5$
In Stock

Style 75

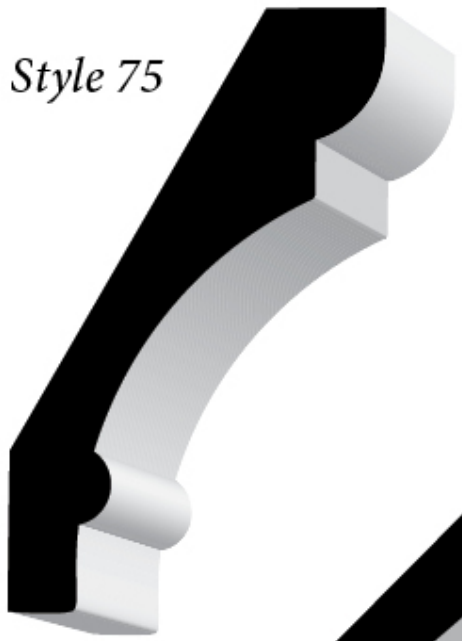

DC753.9
 $\frac{3}{4} \times \frac{3}{8}$
Not In Stock



CM758
 $1\frac{1}{4} \times \frac{7}{8}$
Not In Stock



CM756
 $1 \times \frac{5}{8}$
In Stock



CM754.25
 $1 \times \frac{1}{4}$
In Stock



CM753
 $\frac{3}{4} \times 3$
Not In Stock

Style 77

Not Shown		
CM772.5	$\frac{5}{8} \times 2\frac{1}{2}$	Not In Stock

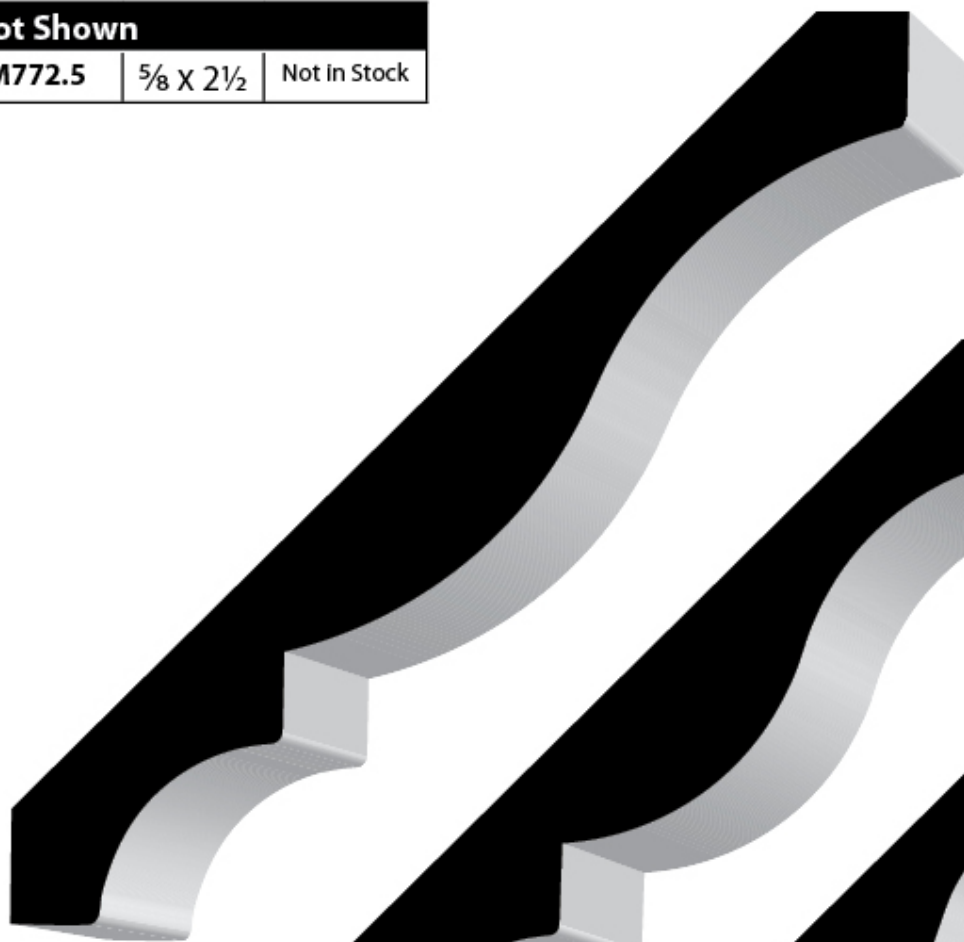

CM777
 $\frac{5}{8} \times 6\frac{7}{8}$
Not In Stock



CM776
 $\frac{5}{8} \times 5\frac{7}{8}$
In Stock



CM774.25
 $\frac{5}{8} \times 4\frac{1}{4}$
Not In Stock



CM772.75
 $\frac{5}{8} \times 2\frac{3}{4}$
In Stock

Style 78

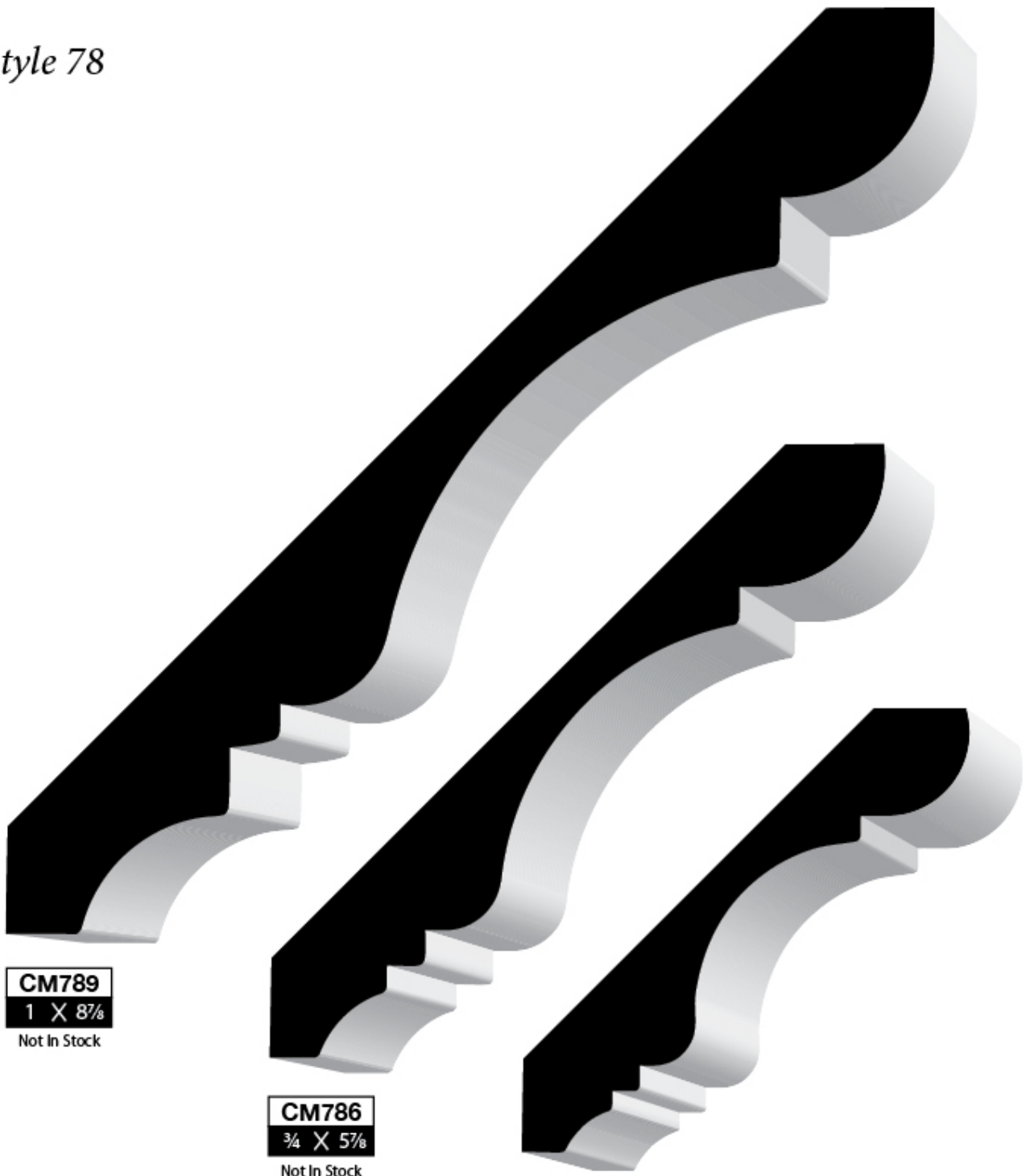

CM789
1 X 8⁷/₈
Not In Stock

CM786
¾ X 5⁷/₈
Not In Stock

CM784.25
¾ X 4¹/₄
Not In Stock

Style 79

Not Shown		
CM797	1 X 6 ⁷ / ₈	Not In Stock
CM795	3 ³ / ₄ X 5	Not In Stock
CM793.5	3 ³ / ₄ X 3 ¹ / ₂	Not In Stock

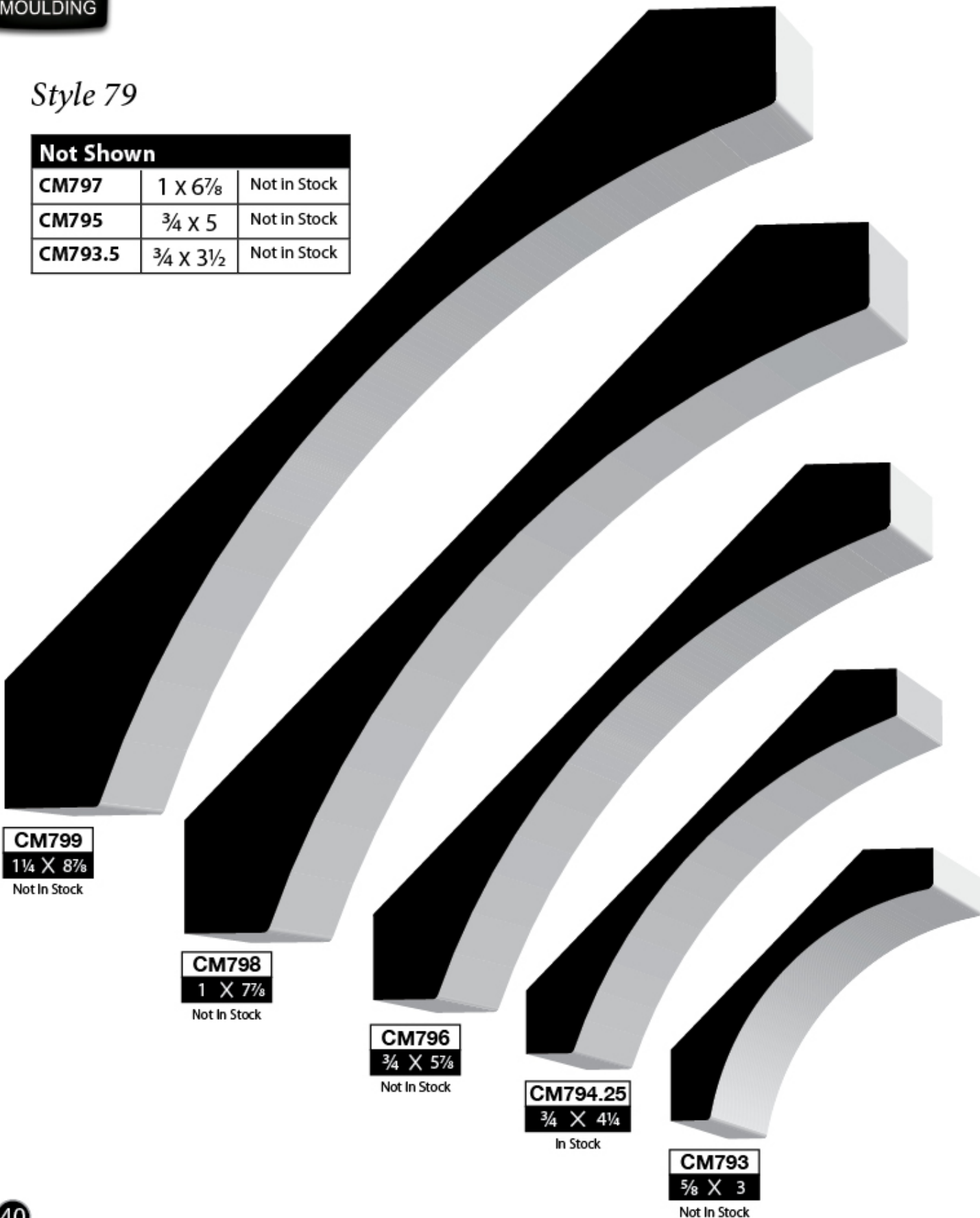

CM799
1¹/₄ X 8⁷/₈
Not In Stock

CM798
1 X 7⁷/₈
Not In Stock

CM796
3³/₄ X 5⁷/₈
Not In Stock

CM794.25
3³/₄ X 4¹/₄
In Stock

CM793
5⁵/₈ X 3
Not In Stock

Panel Molds/Beadboard



3/4 dado

PM8107

1 1/8 X 1 1/2

In Stock



5/8 dado

PM8106

1 X 1 1/2

Not In Stock



1/2 dado

PM8105

7/8 X 1 1/2

In Stock



3/4 dado

PM8407

1 X 1 1/4

Not In Stock



1/2 dado

PM8405

3/4 X 1 1/4

Not In Stock



3/4 dado

PM8507

1 1/4 X 2 1/2

In Stock



5/8 dado

PM8506

1 1/8 X 2 1/2

Not In Stock



1/2 dado

PM8505

7/8 X 2

In Stock

Cove Mold
Various Dimensions
Available.



COVE8607

3/4 X 3/4

Not In Stock



COVE8707

3/4 X 3/4

Not In Stock



PM852.25

3/4 X 2 1/4

In Stock



PM851.75

3/4 X 1 3/4

In Stock



PM851.25

5/8 X 1 1/4

In Stock



COVE8808

1 1/8 X 1

Not In Stock



1/2 dado
&
1/4 dado

H833
1 X 1 1/2

In Stock



1/2 dado

H834
3/4 X 1 1/2

In Stock



3/4 dado

H840
1 X 1 1/2

In Stock



1/4 dado

H844
7/8 X 1 5/8

In Stock



H887
3/8 X 3 1/2

Not In Stock

H887A
1/2 X 5 1/2

Not In Stock



H888
7/16 X 3 1/4

Not In Stock



H888A
7/16 X 6 1/4

In Stock



VG5.5
 $\frac{3}{4} \times 5\frac{1}{2}$
Not In Stock



MVB-VG5.5
 $\frac{3}{4} \times 5\frac{1}{2}$
In Stock

Reversible to use either side



BB5.5
 $\frac{3}{4} \times 5\frac{1}{2}$
Not In Stock

Window Sill Material Available in Poplar & Knotty Alder



WSM2.5
 $2\frac{1}{4} \times 2\frac{1}{2}$
In Stock



WSM2
 $1\frac{3}{4} \times 2$
In Stock

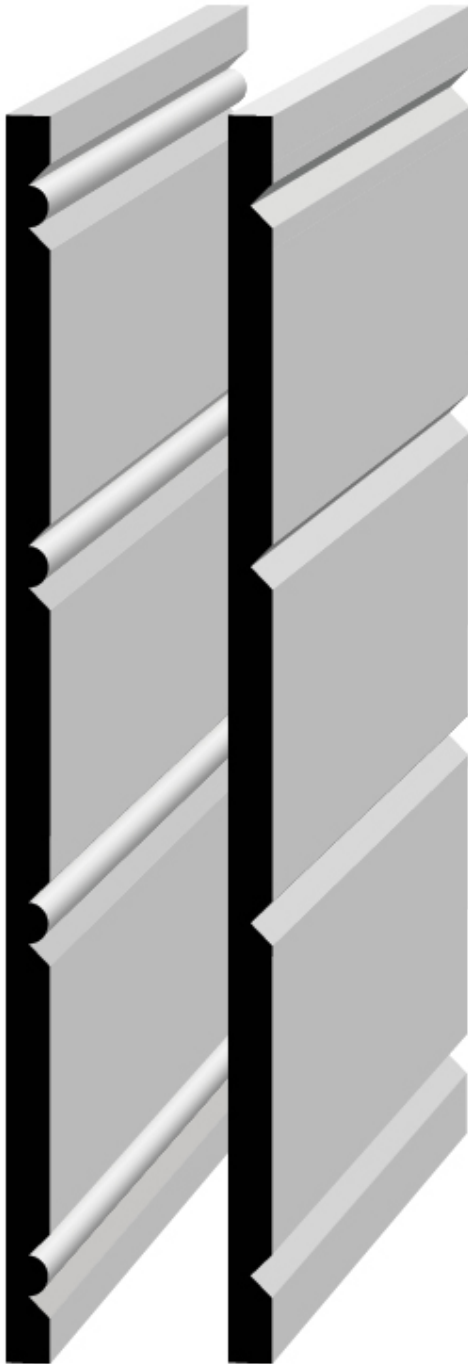

BeadBoard 4' x 8' Panels

Part #	Thickness	Spacing
H7012	1/4"	2" center
H7002	1/2"	2" center
H7013	1/4"	3" center
H7003	1/2"	3" center
H7014	1/4"	4" center
H7004	1/2"	4" center
H7016	1/4"	6" center
H7006	1/2"	6" center
H7018	1/4"	8" center
H7008	1/2"	8" center

Special sizes and spacing available upon request

Also available in veneers

V-Groove 4' x 8' Panels

Part #	Thickness	Spacing
H7012V	1/4"	2" center
H7002V	1/2"	2" center
H7013V	1/4"	3" center
H7003V	1/2"	3" center
H7014V	1/4"	4" center
H7004V	1/2"	4" center
H7016V	1/4"	6" center
H7006V	1/2"	6" center
H7018V	1/4"	8" center
H7008V	1/2"	8" center

Special sizes and spacing available upon request

Also available in veneers



A115
 $\frac{3}{4} \times 1\frac{1}{2}$
 In Stock



A118
 $\frac{1}{2} \times 1\frac{3}{4}$
 Not In Stock



A119
 $\frac{1}{2} \times 1\frac{1}{2}$
 In Stock



A133
 $\frac{3}{4} \times 1\frac{1}{2}$
 In Stock



A390
 $\frac{5}{8} \times 2\frac{5}{8}$
 Not In Stock



A391
 $\frac{9}{16} \times 1\frac{13}{16}$
 Not In Stock



F648
 $1\frac{1}{4} \times 2\frac{1}{2}$
 In Stock



F628
 $1\frac{1}{4} \times 2$
 In Stock



F649
 $1\frac{1}{4} \times 1\frac{7}{8}$
 Not In Stock



F646
 $\frac{3}{4} \times 1\frac{1}{4}$
 In Stock



A125
 $1\frac{1}{4} \times 3\frac{3}{16}$
 Not In Stock



A190
 $\frac{3}{4} \times 3$
 In Stock

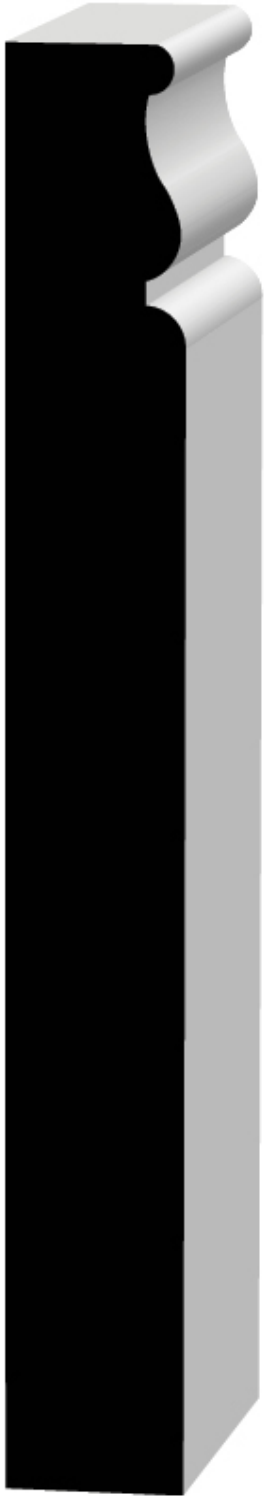

P940
1 X 8 X 20"
In Stock

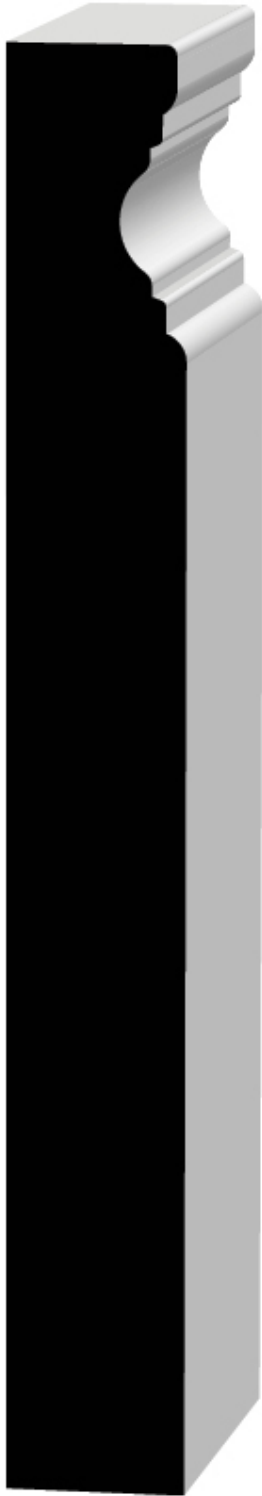

P941
1 X 8 X 20"
In Stock



P942
1 X 8 X 20"
In Stock



P945
1 X 8 X 20"
In Stock

Corner Blocks

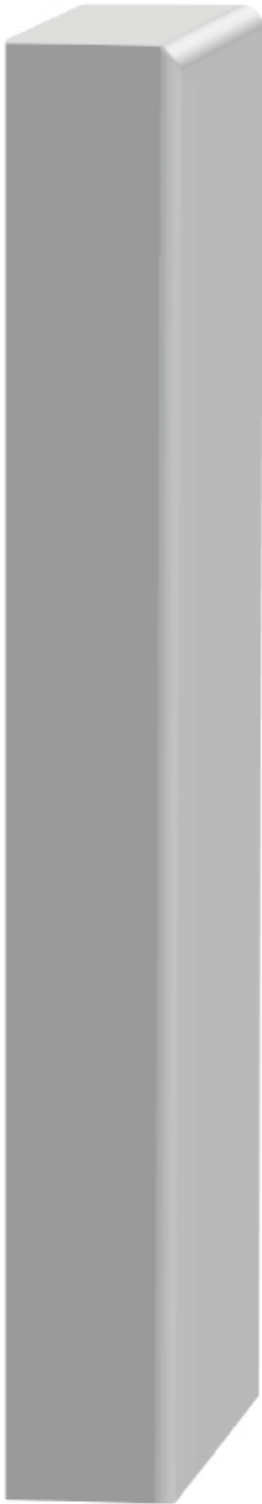

E3E
Various
Not In Stock

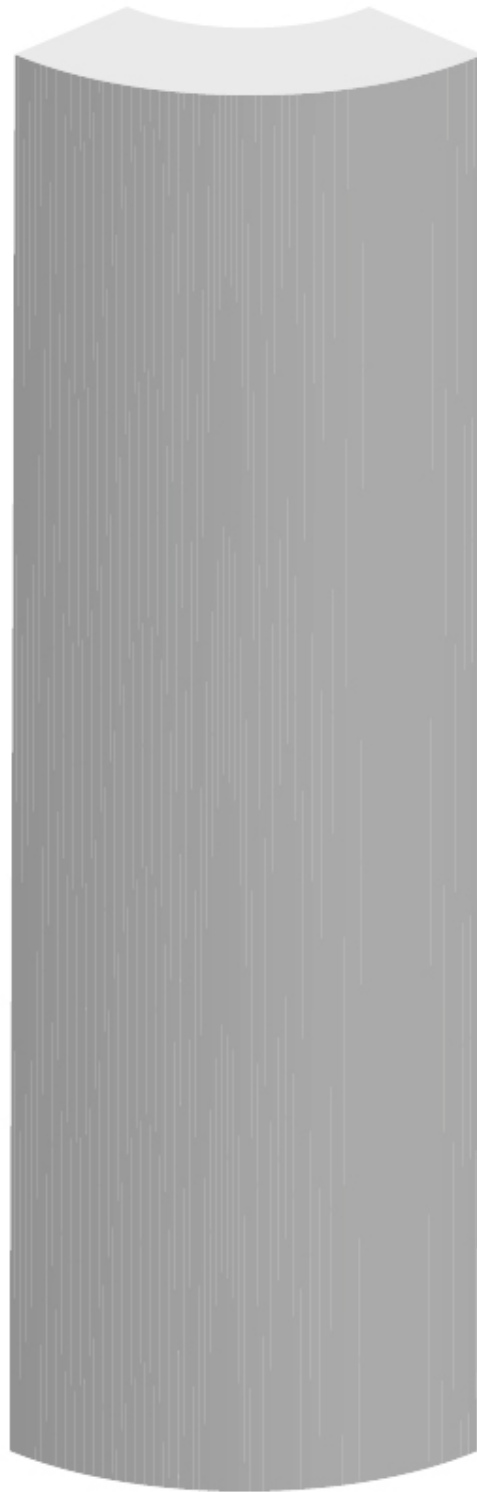

CB750-1
Various
In Stock



In Stock

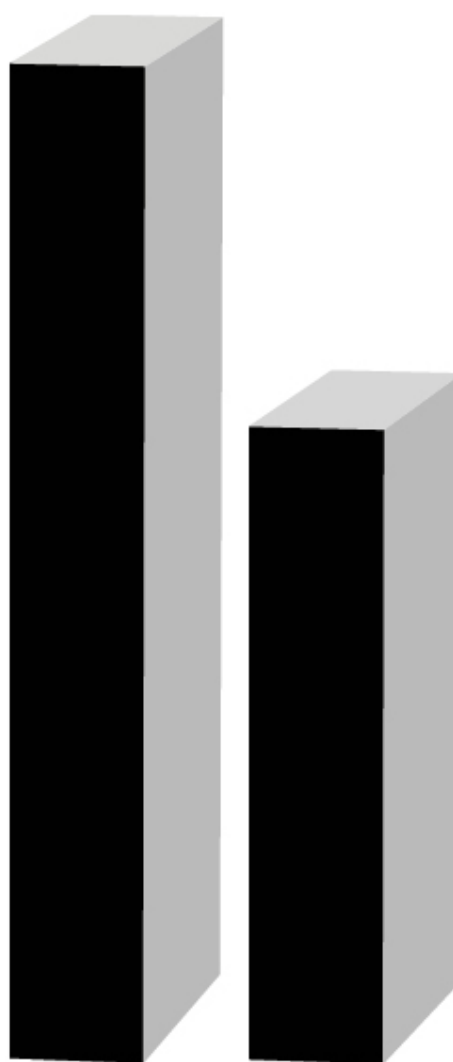

In Stock

Flat Stock MDF	
Part #	Size
FS1X2	1 ¹ / ₁₆ X 1 ¹ / ₂ X 16'
FS1X3	1 ¹ / ₁₆ X 2 ¹ / ₂ X 16'
FS1X4	1 ¹ / ₁₆ X 3 ¹ / ₂ X 16'
FS1X5	1 ¹ / ₁₆ X 4 ⁹ / ₁₆ X 16'
FS1X6	1 ¹ / ₁₆ X 5 ¹ / ₂ X 16'
FS1X7	1 ¹ / ₁₆ X 6 ⁹ / ₁₆ X 16'

Special sizes and special orders
available upon request

Flat Stock Knotty Alder	
Part #	Size
S4S 1 X 4	3/4 X 3 ¹ / ₂
S4S 1 X 6	3/4 X 5 ¹ / ₂
S4S 1 X 8	3/4 X 7 ¹ / ₄
S4S 1 X 10	3/4 X 9 ¹ / ₄
S4S 1 X 12	3/4 X 11 ¹ / ₄

Special sizes and special orders
available upon request

Interior Door Jamb Material

Various Widths & Lengths Available



Exterior Door Jamb Material

Various Widths & Lengths Available



Interior Window Jamb Material

Various Widths & Lengths Available



Door Stop

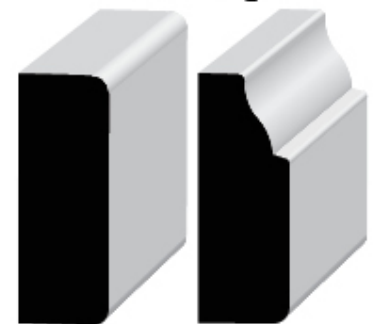

In Stock

Not In Stock

1/2 X 1 1/4

Brick Mold



BM3	BM2.5
1 1/4 X 3	1 1/4 X 2 1/2
In Stock	In Stock

BM2
1 1/4 X 2
In Stock